

SWIPOWER ST SERIES

INVERTER 1KVA-6KVA

Standalone Inverter



ST1000-48-220 ST2000-48-220 ST3000-48-220 ST4000-48-220 ST5000-48-220

ST1000-48-110 ST2000-48-110 ST3000-48-110 ST4000-48-110 ST6000-48-220

IMPORTANT SAFETY INSTRUCTIONS

Before using the product, read all instructions and cautionary markings on the product and any equipment connected to the product.

This unit is designed for indoor use only. Do not expose the product to rain or snow; install only in a clean, dry environment.

CAUTION – To reduce the risk of fire hazard, do not cover or obstruct the ventilation openings. Do not install the inverter in a zero-clearance compartment.

CAUTION – Unless otherwise noted, use of an attachment not recommended or sold by the product manufacturer may result in a risk of fire, electric shock, or injury to persons.

CAUTION – Do not operate the product if it has received a sharp blow, it has been dropped, or otherwise damaged in any way – return it to a qualified service center for repair.

CAUTION – Do not disassemble the product – call our qualified service centers for servicing. Incorrect reassembling may result in a risk of electrical shock or fire.

CAUTION – The AC Neutral Output is floating when the unit is powered by Batteries while in Invert Mode. Ensure that any electrical equipment, connected as a load, is properly grounded.

WARNING – The input and output voltages of the product are hazardous. Extreme caution should be maintained when servicing or touching conductive components connected to the product.

Mechanical Safety

Power equipment can reach extreme temperatures under load.

Use caution around sheet metal components and sharp edges.

Electrical Safety

WARNING

To avoid a risk of fire and electric shock, make sure that existing wiring is in good condition and that wire is not undersized. Do not operate the inverter with damaged or substandard wiring.

Before working with any live battery or power system, follow these precautions:

- Remove all metallic jewelry; e.g., watches, rings, metal rimmed glasses, necklaces.
- Wear safety glasses with side shields (and prescription lenses if necessary) at all times during installation.
- Use OSHA approved insulated hand tools.

Do not work alone under hazardous conditions.

Ensure no liquids or wet clothes contact internal components.

Battery Safety

Servicing and connection of batteries shall be performed by, or under the direct supervision of, personnel knowledgeable of batteries and the required safety precautions.

Never reverse DC+ and DC- to battery.

Keeps the battery away from heat sources including direct sunlight, open fires, microwave ovens and high-voltage container. Temperatures over 60°C may cause damage. Make sure the area around the battery is well ventilated. Always wear eye protection, rubber gloves, and a protective vest when working near batteries. Remove all metallic objects from hands and neck.

Use OSHA approved insulated hand tools. Do not rest tools on top of batteries.

Have plenty of fresh water and soap nearby in case battery acid contacts skin, clothing, or eyes.

If battery acid contacts skin or clothing, wash immediately with soap and water. If acid enters your eye, immediately flood it with running cold water for at least twenty minutes and get medical attention immediately.

If you need to remove a battery, always remove the grounded terminal from the battery first. Make sure all accessories are off so you don't cause a spark.

WARNING

Follow battery manufacturer's safety recommendations when working around battery systems.

WARNING

Do not smoke or present an open flame when batteries (especially vented batteries) are on charge.

Batteries vent hydrogen gas when on charge, which creates an explosion hazard.

Batteries are hazardous to the environment and should be disposed of safely at a recycling facility. Consult the battery manufacturer for recommended local authorized recyclers.

Wiring Requirements

Inverter is intended to be installed as part of a permanently grounded electrical per the National Electric Code ANSI/NFPA 70 (current edition). This is the single point earth ground for the unit.

The ground on the Inverter is marked with this symbol: G / 

The AC voltage and current on the Inverter is marked with this symbol: L / N

The DC voltage and current on the Inverter is marked with this symbol: + -

TABLE OF CONTENTS

SECTION	PAGE
1	Introduction 1
1.1	Scope of the Manual 1
1.2	Product Overview 1
2	Inspection 1
2.1	Packing Materials 1
2.1.1	Returns for Service 2
2.2	Check for Damage 2
3	Installation and Wiring 3
3.1	Where to Install 3
	WARNING 3
3.2	AC Safety Grounding 3
3.3	DC Wiring Connections 4
4	Operation 5
4.1	Front Panel 5
4.1.3	LED Indicators 6
4.1.4	LCD Menu Structure 7
	System Parameter Settings 8
4.2	Rear Panel 8
4.2.1	DC Input 9
4.2.2	AC Input 9
4.2.4	AC Output 9
4.2.5	Alarm Relay 10
4.3	Pre-Operation Check 10
	Inverter Operation Check 10
4.4	Status Monitoring 10
4.5	Turning On the Load 10
5	Maintenance and Troubleshooting 11
5.1	Preventative Maintenance 11
5.2	Troubleshooting Guide 11
6	Specifications 12
6.1	Technical specificationn 12
6.2	Environmental 14
6.3	Standards 14
6.4	Outline Drawings 14

1 Introduction

1.1 Scope of the Manual

This instruction manual explains the features, installation, startup and maintenance of the standalone inverter. This manual applies to standalone inverters (120Vac) and (230Vac).

NOTE: *Images contained in this document are for illustrative purposes only and may not exactly match your installation.*

1.2 Product Overview

The ST series inverter provides highly reliable AC power in a compact 2RU high, 19" wide rack mountable design.

High efficiency, better overload performance, and compact design make the INVERTER an outstanding and highly reliable power solution for various telecom applications.

The built-in Automatic

Transfer Switch (ATS) function adds greater reliability by ensuring that the INVERTER continues to provide uninterrupted power to critical loads even when one of the power sources become unavailable.

Features:

- Designed for telecom grade applications
- High quality pure sine wave output
- 150% overload for up to 8 seconds
- Up to 91% efficiency
- Unity output power factor
- ARM chip design for reliable performance
- Built-in automatic transfer switch for higher reliability
- LCD display for real time status monitoring and configuration
- RS485 interface for communication and connectivity to a PC
- RoHS compliant
- Low audible noise <55dBa
- Wide operating temperature range, -20 to 59 °C/ -4 to 138 °F; full performance from -20 to 50 °C/ -4 to 122 °F

2 Inspection

2.1 Packing Materials

Swipower is committed to providing products and services that meet our customers' needs and expectations in a sustainable manner, while complying with all relevant regulatory requirements. As such Swipower strives to follow our quality and environmental objectives from product supply and development through to the packaging for our products.

Packaging assemblies and methods are tested to International Safe Transit Association standards.

Rectifiers and batteries are shipped on individual pallets and are packaged according to the manufacturer's guidelines.

Almost all of Swipower's packaging material is from sustainable resources and or is recyclable.

2.1.1 Returns for Service

Save the original shipping container. If the product needs to be returned for service, it should be packaged in its original shipping container. If the original container is unavailable, make sure that the product is packed with at least three inches of shock-absorbing material to prevent shipping damage.

Swipower Technologies is not responsible for damage caused by improper packaging of returned products.

2.2 Check for Damage

Before unpacking the product, note any damage to the shipping container. Unpack the product and inspect the exterior for damage. If any damage is observed, contact the carrier immediately.

Continue the inspection for any internal damage. In the unlikely event of internal damage, inform the carrier and contact Swipower Technologies for advice on the impact of any damage. The inventory included with your shipment depends on the options you have ordered. The options are clearly marked on the shipping container labels and bill of materials.

3 Installation and Wiring

3.1 Where to Install

WARNING

This system is designed to be installed in a restricted access location that is inaccessible to the general public.

The power inverter should be installed in a location that meets the following requirements:

- **Dry:** Do not allow water to drip or splash on the inverter.
- **Cool:** Ambient air temperature should be between -20°C and 58°C.
- **Safe:** Do not install in a battery compartment or other areas where flammable fumes may exist, such as fuel storage areas or engine compartments.
- **Ventilated:** Ensure that all the ventilation openings are unobstructed. Allow at least three inches of clearance from the front, back and top of the inverter for airflow.
- **Dust Free:** Do not install the inverter in a dusty environment where dust, wood particles or other filings/shavings are present that may be pulled into the unit when the cooling fan is operating.
- **Close to Batteries:** Avoid excessive cable lengths but do not install the inverter in the same compartment as batteries. Use the recommended wire lengths and sizes .

Avoid mounting the inverter where it may be exposed to the gases produced by the battery. Prolonged exposure to these corrosive gases will damage the inverter.

3.2 AC Safety Grounding

During the AC wiring installation, AC input and output ground wires are connected to the inverter. The AC input ground wire must connect to the incoming ground from your AC utility source.

The AC output ground wire should go to the grounding point for your loads.

CAUTION: The AC Output Neutral is floating when the unit is powered by batteries. Touching the AC Output Neutral while powered from batteries can result in an electric shock. If the AC Output Neutral is accessible by users or service personnel, attach a warning label to all equipment near any point where Neutral is accessible.

WARNING: Do not operate the unit without connecting it to ground. Electrical shock hazard may result.

3.3 DC Wiring Connections

Connect the cables to the power input terminals on the rear panel of the unit.

【 + 】 is positive, and 【 - 】 is negative. Insert the cables into the terminals and tighten the nut to securely clamp the wires.



WARNING

Before proceeding, confirm that the DC input cable is connected correctly. Make sure that all DC connections are tight (torque to 1.5 ft. lbs.). Loose connections will overheat and could result in a potential hazard.

Follow this procedure to connect the battery cables to the DC input terminals on the unit.

The cables should be as short as possible (ideally, less than 10 feet / 3 meters) and large enough to handle the required current in accordance with the electrical codes or regulations applicable to your installation. Cables that are not an adequate gauge (too narrow) or are too long will cause decreased inverter performance such as poor surge capability and frequent low input voltage warnings and shutdowns. These low input voltage warnings are due to DC voltage drop across the cables from the inverter to the batteries. The longer and narrower these cables, the greater the voltage drop.

CAUTION – Increasing your DC cable size will help improve the situation.

NOTE: *We recommend 100A cables (48Vdc input) for optimum inverter performance (applies to both 110V and 220Vseries). Use only high quality copper wiring and keep cable length short (from 3-6 feet).*

4 Operation

4.1 Front Panel

The interface for signals and controls is located on the front panel.

Current voltage display accuracy is +/- 2%.

- **Control:** Keypad to set major parameters
- **Display:** LCD and 4-LEDs to display major parameters, status and alarms

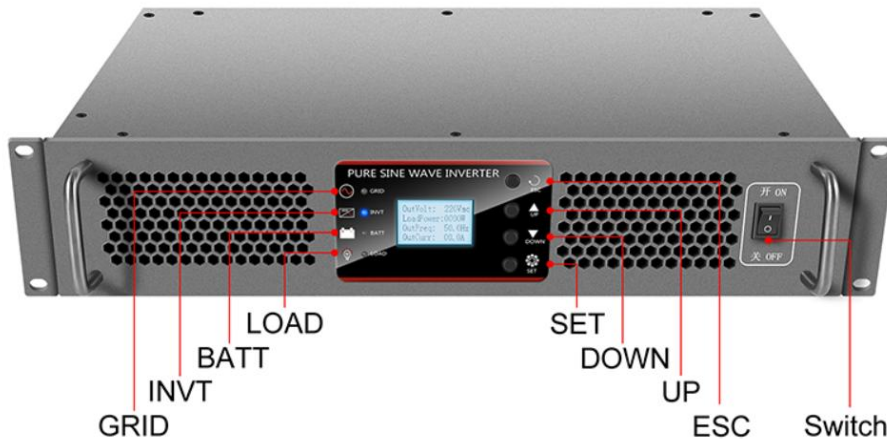

4.1.1 ON/OFF Switch

The POWER ON/OFF switch is a lock switch that turns the unit on or off by pressing it once.

4.1.1.1 Switch on:

When the unit is connected to the DC, LCD will show content, press ON/OFF switch, unit will provide power to load in 10s.

When the unit is only connected to the AC, LCD will show content, press ON/OFF switch, unit will provide power to load in 3s.

4.1.1.2 Switch off:

When unit is working, press ON/OFF switch will turn unit off, if DC or AC power exists, LCD will show content continually.

Unit shuts off when input power out of range, and it can auto restart if on/off switch is at on position and input DC or AC power recover.

4.1.3 LED Indicators

GRID LED: When there is mains input and mains output, the GRID LED is on and in a bypass state;

INVT LED: When the bypass input fails and the inverter works, the INVT LED is on;

BATT LED: When the battery or DC input voltage is not within the working range of the inverter, the BATT LED is on;

LOAD LED: When the inverter is faulty, the LOAD LED is on.

LED Display Status

	“GRID” LED	“INVT” LED	“BATT” LED	“LOAD”LED	BUZZER
1) Grid output	ON	OFF			
2) Inverter output	OFF	ON			
3) Battery high voltage			Flashing once every 1 second		One sound every 1 second
4) Battery low voltage			Flashing once every 3 seconds		One sound every 3 seconds
5) Overload 150%				ON	Solid
6) Overload 125~150%				Flashing once every 1 second	One sound every 1 second
7) Over load 100~125%				Flashing once every 3 seconds	One sound every 3 seconds
8) Over-temperature			Flashing once every 1 second	Flashing once every 1 second	One sound every 1 second
9) Inverter fault			ON	ON	Solid
10) Frequency Abnormal			ON	ON	Solid

4.1.3.1 Power On:

When the inverter is in “Power On” mode, the green LED and the yellow LED are flickering synchronously without any alarm.

4.1.3.2 Overload and Overload Fault:

When overload fault alarm occurs, the yellow LED and red LED turn on at the same time, while overload alarm occurs, only the yellow LED turns on.

4.1.3.3 Priority:

If more than one warning exists at the same time, then the LED will display the highest priority.

4.1.4 LCD Menu Structure

Page-turning key: Press the UP or DOWN key to turn pages. The LCD screen has three pages, and each page displays four lines.

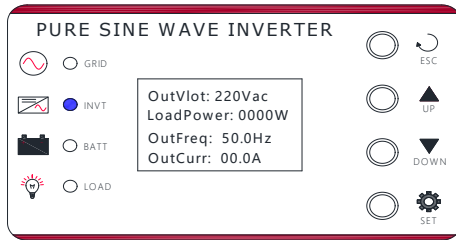

The first page

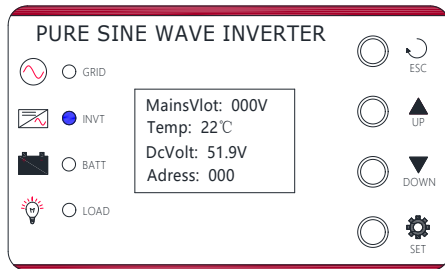

The second page

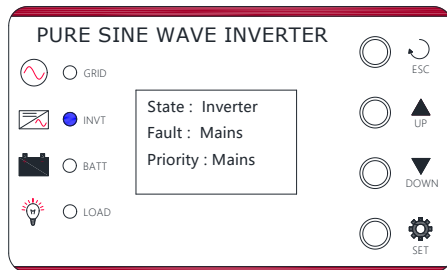

The third page

System Parameter Settings

SET key: long press SET to enter parameter SETting, select UP/DOWN to set parameters, and then press SET key to confirm after setting, which will take effect after confirmation.

Parameter	Setting Option
address	000-015
priority	Mains/BAT
MUTE	YES/NO
Language	CHN/EN
frequency	50Hz/60Hz

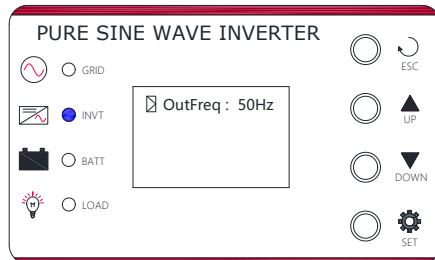
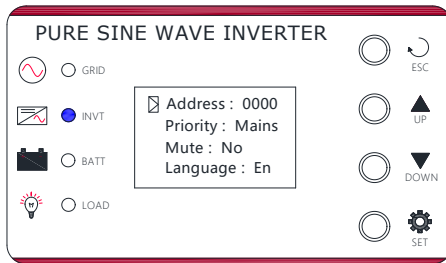

4.2 Rear Panel

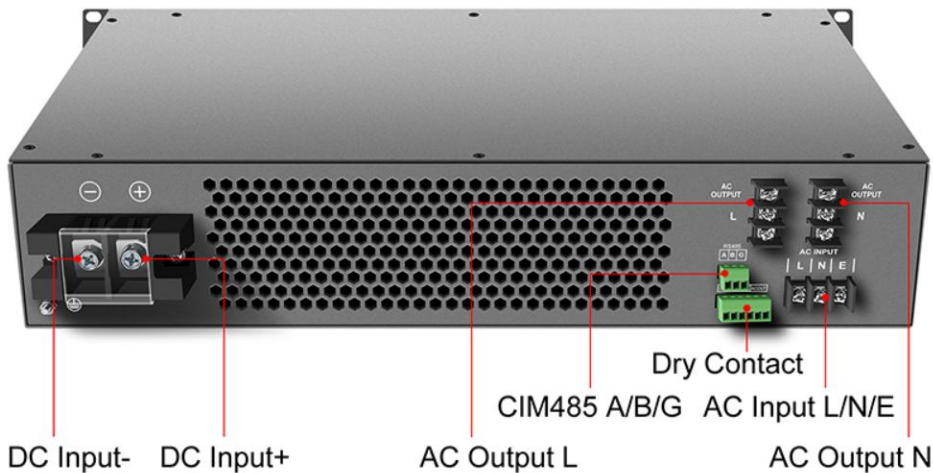

Located on the rear panel are the terminations for wiring:

4.2.1 DC Input

Connect to a 48Vdc battery or DC power source.

Upper terminal 【 + 】 is positive, and 【 - 】 is negative.

4.2.2 AC Input

230Vac model; 120Vac model

4.2.4 AC Output

230Vac model; 120Vac model

4.2.5 Alarm Relay

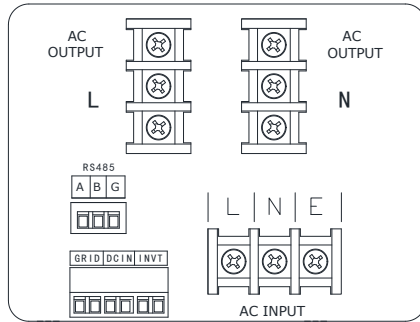

Module Status	Dry Contact Status	
	Alarm_NC & Com	Alarm_NO & Com
Grid Fault	---	Closed
DC abnormal	---	Closed
Inverter Fault	Open	---

4.3 Pre-Operation Check

Inverter Operation Check

- Check if the DC input polarity is connected correctly.
- Ensure the input voltage is in the standard range.
- Check connecting wiring size based on the wiring table.
- Check if the ground wiring is connected for safety, to avoid electrical shock.
- The breakers are at ON position.
- To operate the Auto Transfer Switch, it is necessary to make sure that the nominal voltage and frequency of the grid match the corresponding settings of the unit.

Verify that the nominal frequency and voltage values are equal to those of the grid.

4.4 Status Monitoring

When the inverter is properly installed with power on, the buzzer rings 5 times, and the LED lights up in turn, then the LCD screen will light for self-diagnosis. After a few seconds, the general status is shown as follows:

```

OutVolt: 220Vac
LoadPower:0000W
OutFreq: 50.0Hz
OutCurr: 00.0A
  
```

4.5 Turning On the Load

Check that the rated input power of the load is less or equal to the rated output power of the inverter.

Connect the load to the inverter as described previously.

Press the ON/OFF switch to turn the unit ON.

5 Maintenance and Troubleshooting

5.1 Preventative Maintenance

The following preventive maintenance routines should be considered as a minimum requirement. Your installation may require additional preventive maintenance to assure optimal performance from your installed inverter and associated equipment. These routines should be performed twice a year (more often if required). We strongly recommend a contract with Customer Support Services for preventive and remedial maintenance. The technician or electrician performing preventive maintenance on the equipment must read and understand thoroughly this manual and be familiar with the indicators, controls, and operation of the equipment.

5.2 Troubleshooting Guide

If the inverter fails to operate properly after having the installation and setup of the inverter thoroughly re-examined, use the troubleshooting table to determine the probable cause(s) and solution(s) to resolve error conditions. For unlisted error conditions, please contact your local dealer for technical assistance.

Error Condition	Possible Cause	Recommendation
No AC output and all LEDs off.	Lack of input power.	Ensure input cables are all firmly connected to power source. Check if power source is not yet switched on, or is low in power.
Both Batt and Load LEDs flicker once every 1 second.	Turn off the output due to internal overheating.	Whether the fan turns, the vent is not blocked, the indoor temperature is not too high, reduce the load, wait for 10 minutes for the power supply to cool down, and then restart.
The load LED is on, and the buzzer is ringing.	The load is overloaded by more than 150% or shut down due to internal failure.	Ensure the load is no higher than 100% of the total power rating. Reduce as required.
The Batt LED is on, flashing once every 3 S, and the buzzer sounds once every 3 seconds.	Input DC voltage is too low	Check whether the DC input voltage meets the requirements and whether the voltage is too low.
The Batt LED is on, flashing once every second, and the buzzer sounds once every second.	Input DC voltage is too high	Check whether the DC input voltage meets the requirements and whether the voltage is too high.
The load LED flashes once every 3 seconds, and buzzer sounds once every 3 seconds.	Load overload 100~125%	Check whether the output load exceeds the rated load. If it exceeds the rated load, remove the redundant load.
When the mains supply is connected, the grid LED are not on.	The mains voltage and frequency are out of the power input range.	Check whether the mains voltage and frequency are beyond the power input range. Check whether the power switch on the panel is turned on.
When DC is connected, the inverter does not respond when the power switch is turned on.	The input DC voltage does not meet the requirements or is too low, and the positive and negative poles of the input are reversed.	Check whether the DC input voltage meets the requirements, whether the voltage is too low and whether the input is reversed.
Can't switch between DC and bypass	The mains voltage and frequency are out of the power input range.	Check whether the mains voltage and frequency are beyond the power input range.

6 Specifications

6.1 Technical specification

Item	ST1000-48-110	ST1000-48-220	ST2000-48-110	ST2000-48-220	ST3000-48-110	ST3000-48-220
Rated Input Voltage	48VDC					
Input Voltage Range	40-60VDC					
Under Voltage Warning Threshold	42VDC					
Input Protection:	Reverse polarity protection					
Psophometric Noise Voltage	≤ 1.0mV ITU-T O.41 (16.66 to 6000Hz)					
Wide Band Noise	<1.0mV (psophometric, 25Hz to 5kHz) <20mVrms (25Hz to 20kHz)					
Peak to Peak Noise	<150mV up to 100MHz					
Output Voltage	100VAC(±5%) 110VAC(±5%) 120VAC(±5%)	220VAC(±5%) 230VAC(±5%) 240VAC(±5%)	100VAC(±5%) 110VAC(±5%) 120VAC(±5%)	220VAC(±5%) 230VAC(±5%) 240VAC(±5%)	100VAC(±5%) 110VAC(±5%) 120VAC(±5%)	220VAC(±5%) 230VAC(±5%) 240VAC(±5%)
Output Frequency	50/60 ± 0.1Hz					
Over Voltage Threshold	138Vac	276 Vac	138Vac	276 Vac	138Vac	276 Vac
Under Voltage Threshold	89Vac	176Vac	89Vac	176Vac	89Vac	176Vac
Output Continuous Power	800W		1600W		2400W	
Surge power	1600W		3200W		4800W	
Output Wave	Pure sine wave					
Distortion THD	THD≤5% ①	THD≤3% ①	THD≤5% ①	THD≤3% ①	THD≤5% ①	THD≤3% ①
Efficiency	90%	91%	90%	91%	90%	91%
No- load current	<0.58A	<0.58A	<0.65A	<0.65A	<0.8A	<0.8A
Transfer Time	8ms when Inverter → Mains AC; 10ms when Mains AC → Inverter					
Dimension	88.8×255×440mm			88.8×330×440mm		
Weight	5KG		6KG		7.5KG	
Current Limitation:	Electronic current limitation at overloads and short circuits					
Isolation AC-enclosure:	Basic isolation (Pri-Gnd) 2121Vdc/1min					
Isolation AC-DC:	Reinforced isolation (Pri-Sec) 4242Vdc/1min					
Surge Protection:	EN61000-4-5, ANSI/IEEE C62.41, STD 587- 1980					
Dynamic Response:	Better than ±10% according to IEC 62040-3 Class 1					
Over Load Protection:	1.0x Inom permanent overload capacity @30°C (86°F) 1-1.25 x Inom >30s 1.25-1.5 x Inom >8s					

① Test condition: Rated Input Voltage, Output Continuous Power, Resistive load.

Item	ST4000-48-110	ST4000-48-220	ST5000-48-220	ST6000-48-220
Rated Input Voltage	48VDC			
Input Voltage Range	40-60VDC			
Under Voltage Warning Threshold	42VDC			
Input Protection:	Reverse polarity protection			
Psophometric Noise Voltage	$\leq 1.0\text{mV}$ ITU-T O.41 (16.66 to 6000Hz)			
Wide Band Noise	<1.0mV (psophometric, 25Hz to 5kHz) <20mVrms (25Hz to 20kHz)			
Peak to Peak Noise	<150mV up to 100MHz			
Output Voltage	100VAC($\pm 5\%$) 110VAC($\pm 5\%$) 120VAC($\pm 5\%$)	220VAC($\pm 5\%$) 230VAC($\pm 5\%$) 240VAC($\pm 5\%$)	220VAC($\pm 5\%$) 230VAC($\pm 5\%$) 240VAC($\pm 5\%$)	220VAC($\pm 5\%$) 230VAC($\pm 5\%$) 240VAC($\pm 5\%$)
Output Frequency	50/60 $\pm 0.1\text{Hz}$			
Over Voltage Threshold	138Vac	276 Vac	276 Vac	276 Vac
Under Voltage Threshold	89Vac	176Vac	176Vac	176Vac
Output Continuous Power	3200W		4000W	4800W
Surge power	6400W		4800W	9600W
Output Wave	Pure sine wave			
Distortion THD	THD $\leq 5\%$ ①	THD $\leq 3\%$ ①	THD $\leq 3\%$ ①	THD $\leq 3\%$ ①
Efficiency	90%	91%	91%	91%
No- load current	<0.85A	<0.85A	<0.9A	<1A
Transfer Time	8ms when Inverter \rightarrow Mains AC; 10ms when Mains AC \rightarrow Inverter			
Dimension	88.8 \times 330 \times 440mm			
Weight	7.5KG		8KG	8KG
Current Limitation:	Electronic current limitation at overloads and short circuits			
Isolation AC-enclosure:	Basic isolation (Pri-Gnd) 2121Vdc/1min			
Isolation AC-DC:	Reinforced isolation (Pri-Sec) 4242Vdc/1min			
Surge Protection:	EN61000-4-5, ANSI/IEEE C62.41, STD 587- 1980			
Dynamic Response:	Better than $\pm 10\%$ according to IEC 62040-3 Class 1			
Over Load Protection:	1.0x Inom permanent overload capacity @30°C (86°F) 1-1.25 x Inom >30s 1.25-1.5 x Inom >8s			

① Test condition: Rated Input Voltage, Output Continuous Power, Resistive load.

6.2 Environmental

Operating Temperature:	-20 to +59°C* (-4 to +138°F) -20 to +50°C (-4 to +122°F) with full performance
Storage Temperature:	-30 to +80°C (-22 to +176°F)
Operating Humidity:	0 to 95% relative, non-condensing
Heat Dissipation:	Forced air cooling
Operating Altitude:	1500m (4922 feet)
Audible Noise:	55dB ETS 300 753 Class 3.1

6.3 Standards

Safety Compliance:	Complies with EN 60950- 1/UL 60950- 1
Certification:	CE
RoHS:	
EMC:	EN300 386:2001 Class B compliance

6.4 Outline Drawings

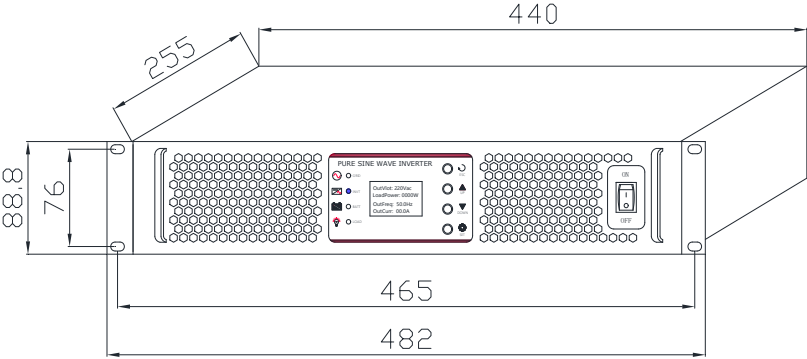

1KVA Inverter Dimension

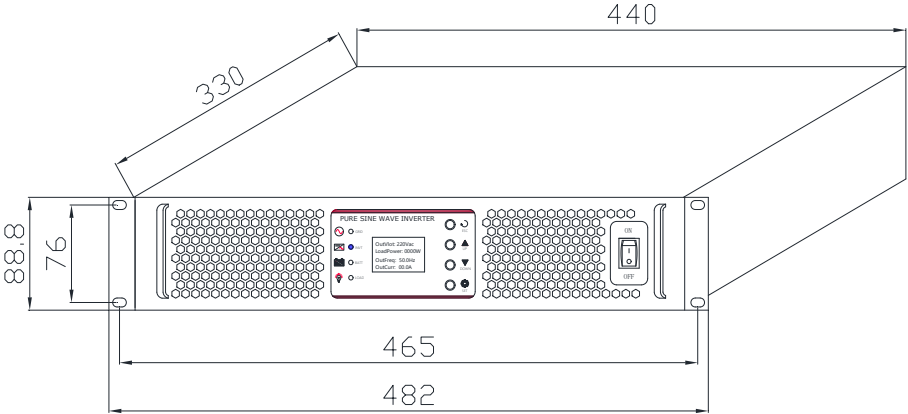

2KVA-6KVA Inverter Dimension

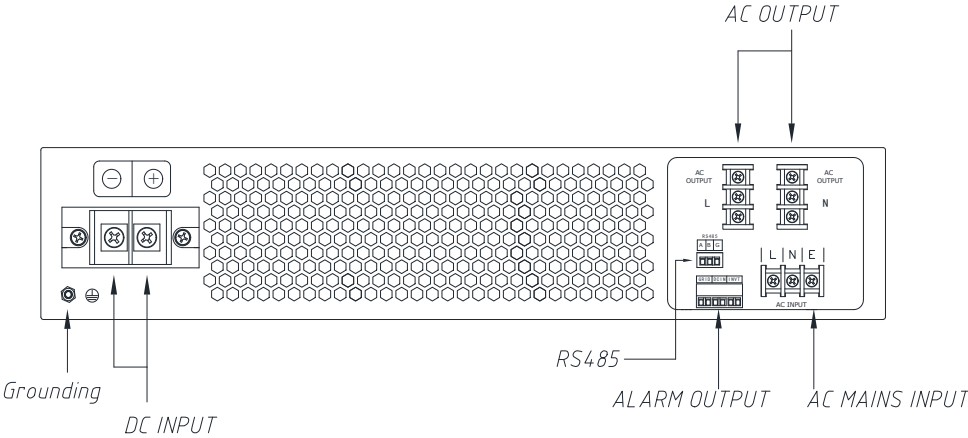

The above information is valid at the time of publication. Consult factory for up-to-date ordering information. Specifications are subject to change without notice.