

SHANGHAI PVSYS NEW ENERGY CO.,LTD

Shanghai Pvsys New Energy Co.,Ltd is the professional manufacturer of solar products in the market for more than 11 years.

Our solar products include solar panel, solar hybrid inverter, controller, pump inverter, battery and other accessories.

We are not only offer these solar products, but also offer the whole complete solar system to our customers. With our professional solution and best offer, customers can save their total cost of the whole solar system.

Our solar system includes: solar on grid system, solar off grid system, DC&AC solar water pump system, solar air conditioner system, solar street light system, solar camera system and solar water treatment system.

We made our system in modularity, it is easy for our customers to maintain the system and it is easy for us to offer the best after sales service.

We hope to have the opportunity to introduce our solar products and solar system to our customers in the world, let's protect our earth together and keep it green.



SHANGHAI PVSYS NEW ENERGY CO.,LTD



SHANGHAI PVSYS NEW ENERGY CO.,LTD



SHANGHAI PVSYS NEW ENERGY CO.,LTD

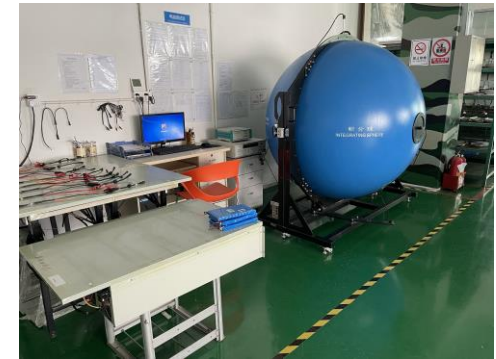

PVS-450W/460W-M10H

PERC Monocrystalline solar panel PVS-450W/460W-M10H

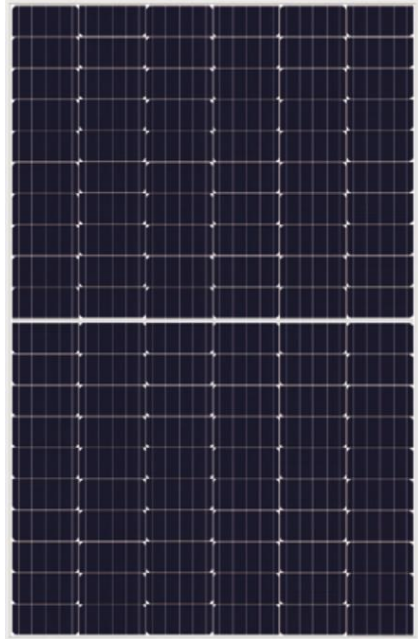







Certification:
CE
IEC61215-1-1:2021
IEC61730-1:2018
IEC61730-2:2018
Fire safety Class C

Redefined the high-efficiency module series by integrating 182mm silicon wafers with multi-busbar and half-cut cell technologies.

Our panel combined creative technology effectively and extremely improved the module efficiency and power output.

KEY FEATURES:

-  Less mismatch to get more power
-  Less power loss by minimizing the shading impact
-  Competitive low light performance
-  3 times EL test to ensure best quality
-  Ideal choice for utility and commercial scale projects by reduced BoS and improved ROI
-  Outstanding reliability proven by PVEL for stringent Environment condition:
Sand , acid, salt and hail stones
2400Pa wind load and 5400Pa snow load
Anti-PID

WARRANTY:

Additional value from linear warranty

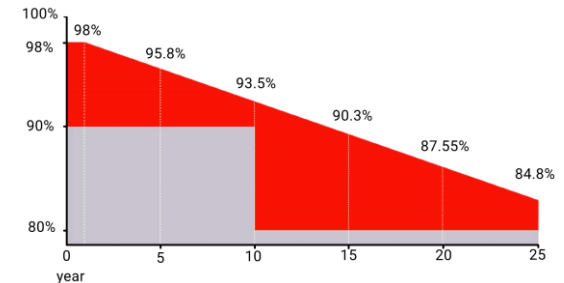

Guarantee on product material and workmanship



Linear power output warranty

PVS-450W/460W-M10H

PERC Monocrystalline solar panel PVS-450W/460W-M10H

Electrical Characteristics:

Module Type	PVS-450W-M10H	PVS-460W-M10H
Maximum Power (Pmp)	450W	460W
Open Circuit Voltage (Voc)	41.32V	41.52V
Short Circuit Current (Isc)	13.76A	13.96A
Maximum Power Voltage (Vmp)	34.28V	34.49V
Maximum Power Current (Imp)	13.13A	13.34A
Module Efficiency at STC(η_m)	20.79%	21.25%
Power Tolerance	(0,+3%)	
Maximum System Voltage	1500VDC	
Maximum Series Fuse Rating	25A	
STC: Irradiance 1000 W/m ² module temperature 25° C AM=1.5 Power measurement tolerance: +/-3%		

PVS-450W/460W-M10H

PERC Monocrystalline solar panel PVS-450W/460W-M10H

Mechanical Specifications:

External Dimensions	1909x1134x35 mm
Weight	22.3 kg
Solar Cells	PERC Mono (120pcs)
Front Glass	3.2mm tempered glass
Frame	Anodized aluminum alloy
Junction Box	IP68, 3 diodes
Output Cables	4.0mm ²
Mechanical Load	Front side 5400Pa Rear side 2400Pa

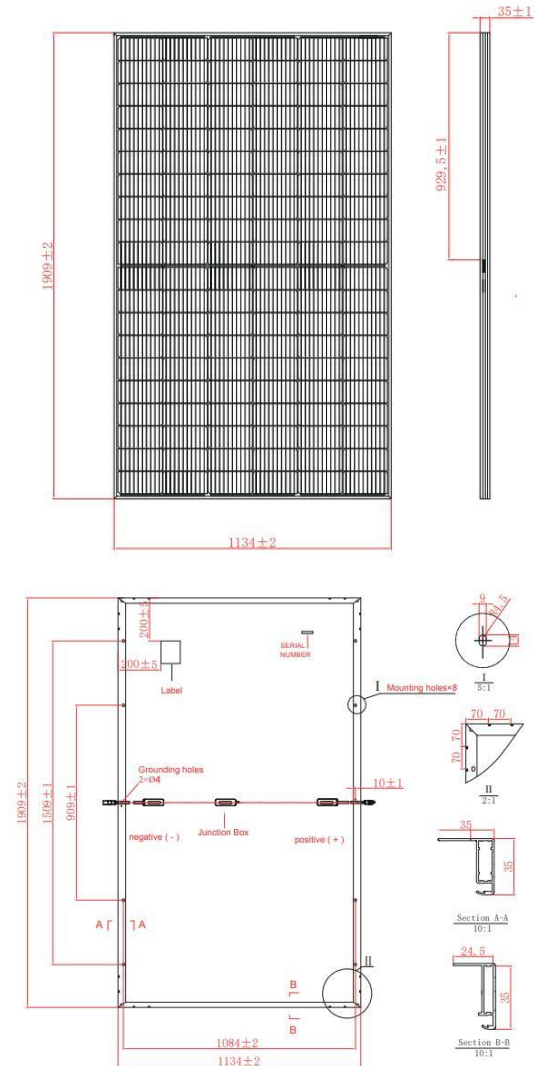

PVS-450W/460W-M10H

PERC Monocrystalline solar panel PVS-450W/460W-M10H

Temperature Characteristics:

Pmax Temperature Coefficient	-0.34 %/° C
Voc Temperature Coefficient	-0.26 %/° C
Isc Temperature Coefficient	+0.05 %/° C
Operating Temperature	-40~+85 ° C
NOCT	45±2 ° C

Packing Configuration:

Container	20'GP	40'HQ
Pieces per Pallet	35	31
Pallets per Container	5	24
Pieces per Container	175	744

I-V Curve

