

LED UFO HIGHBAY - HBF SERIES

Introduction

- ◆ Available in three sizes, the HBF UFO high bay offers three selectable wattage and two CCT, making it versatile enough to handle countless applications.
- ◆ Its standard efficiency is 150 lumen per watt. But it can reach up to 170 lumen per watt, and its highest lumen reaches 52,700 lumens.
- ◆ HBF includes an expansion port to easily add the sensor. It can be configured to adjust brightness and hold time, saving additional energy and costs.
- ◆ It comes standard with a G hanging hook but also available O hanging hook, U bracket mount kit, and Pendant mount adapter for optional.
- ◆ UFO high bay HBF widely used in warehousing, industrial facilities, sports facilities, gymnasiums, etc.

Features

Construction:

- ◆ Die-casting aluminum housing and heatsink for added protection.

Electrical:

- ◆ 0-10v dimmable driver, which can dim from 100% down to off.
- ◆ The Input voltage is AC120-277V/AC120-347V/AC277-480V (50/60Hz).
- ◆ Designed to withstand up to L/N-PE: 6kV, L-N: 4kV surge (120-277V/120-347V/277-480V).
Flicker-free

Optics:

- ◆ LED chips support 4000k and 5000k with CRI>80 .
Sealed optic available in 60° , 90° , and 120° beam angle .

Finish:

- ◆ Black color is Standard .

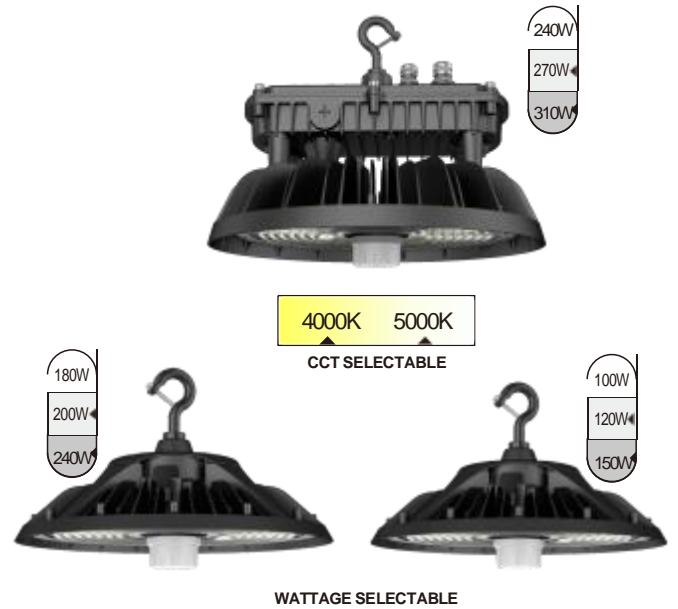

Mounting:

- ◆ Support O/G hook, U bracket mount kit, and Pendant mount adapter for surface or pendant mounting. Safety Hanging kit is optional.

Compliances:

- ◆ cULus listed for wet locations, environment temperature from -40°C to 45°C.
DLC® (DesignLights Consortium) Qualified. Please refer to the DLC website for specific product qualifications at

Warranty:

- ◆ 5-year limited warranty. Complete warranty terms located at:

Ordering Guide

EXAMPLE: X- HBF100W-XXK80AA-XXXYZ

Brand X	Product name HBF	Wattage XXXW	CCT XXK	CRI 80	Input Voltage AA	Sensor XXX	Efficiency Y	Product code Z
ALK	HBF	100W 120W 150W (150/120/100)W 200W 240W (240/200/180)W 310W (310/270/240)W	can be any two numbers 40K=4000K 50K=5000K (40/50)K=4000/ 5000K	80=80Ra	LV=120-277 / 347Vac HV=277-480Vac	Blank=without Sensor SD=Daylight Sensor SW=Microwave Motion Sensor SWN=Networking Wireless Control version Microwave Motion Sensor SP=PIR Sensor SPN=Networking Wireless Control version PIR Sensor	C=General Light Efficiency H=High Light Efficiency	Can be blank, It could be any letter from A to Z

Specificaion

Size	Model	Waitage	Lumen @50K @150lm/w	Lumen @50K @170lm/w	CCT	Lens	Input voltage
Small	X-HBF100W-XXK80AA-XXXYZ	100W	15000lm	17000lm	40K 50K	60° 90° 120°	AC120-277V/ AC120-347V AC277-480V 50/60Hz
	X-HBF120W-XXK80AA-XXXYZ	120W	18000lm	20400lm			
	X-HBF150W-XXK80AA-XXXYZ	150W	22500lm	25500lm			
	X-HBF(150/120/100)W-XXK80AA-XXXYZ	(150/120/100)W	Max. 22500lm	Max. 25500lm			
	X-HBF(150/120/100)W-(40/50)K80AA-XXXYZ	(150/120/100)W	Max. 22500lm	/	40k/50k selectable		
Medium	X-HBF200W-XXK80AA-XXXYZ	200W	30000lm	34000lm	40K 50K	60° 90° 120°	AC120-277V/ AC120-347V AC277-480V 50/60Hz
	X-HBF240W-XXK80AA-XXXYZ	240W	36000lm	40800lm			
	X-HBF(240/200/180)W-XXK80AA-XXXYZ	(240/200/180)W	Max. 36000lm	Max. 40800lm			
	X-HBF(240/200/180)W-(40/50)K80AA-XXXYZ	(240/200/180)W	Max. 36000lm	/	40k/50k selectable		
Large	X-HBF310W-XXK80AA-XXXYZ	310W	46500lm	52700lm	40K 50K	60° 90° 120°	AC120-277V/ AC120-347V AC277-480V, 50/60Hz
	X-HBF(310/270/240)W-XXK80AA-XXXYZ	(310/270/240)W	Max. 46500lm	Max. 52700lm			
	X-HBF(310/270/240)W-(40/50)K80AA-XXXYZ	(310/270/240)W	Max. 46500lm	/	40k/50k selectable		

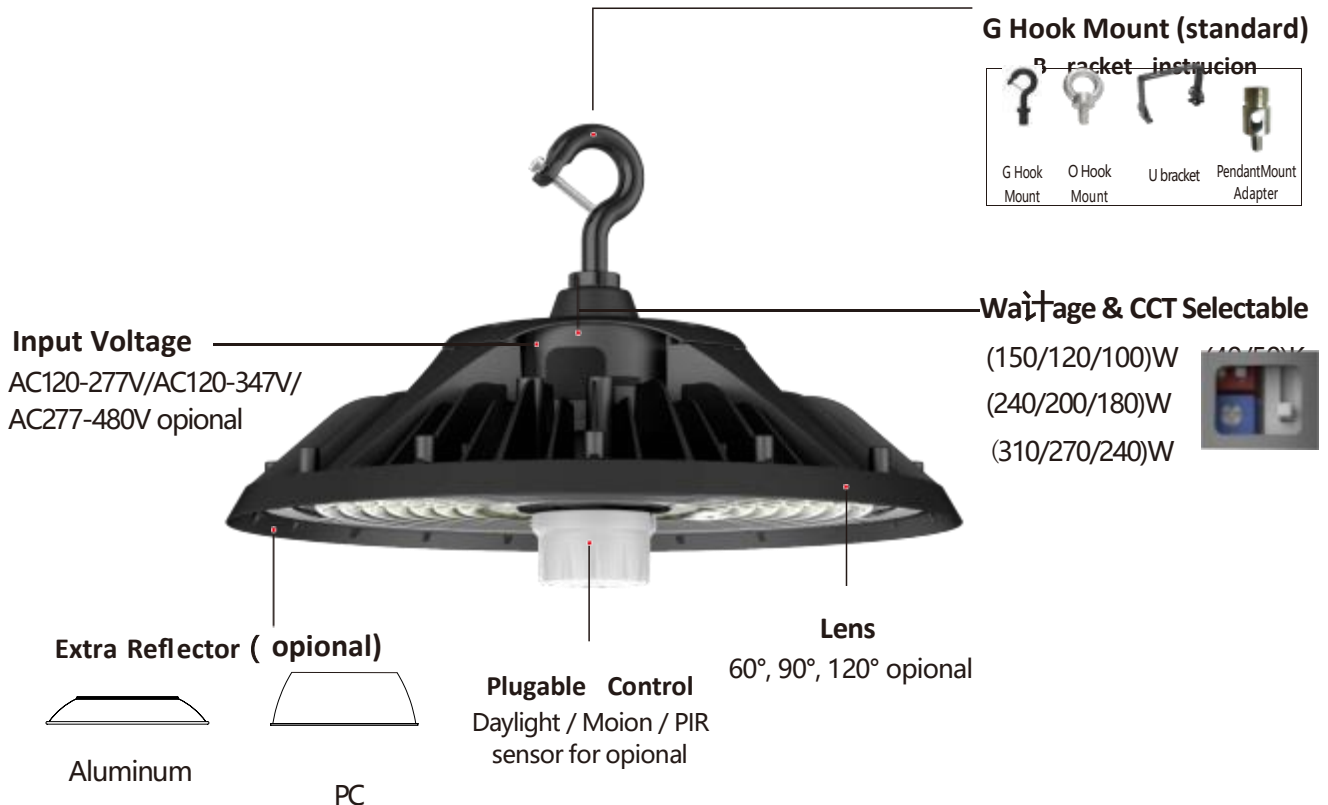

Dimensions & Weight

100W/120W/150W

(AC120-277/347V)

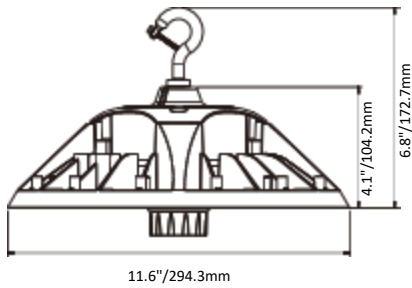

11.6"/294.3mm

Net Weight: 4.9Lbs/2.2KG

200W/240W

(AC120-277/347V)

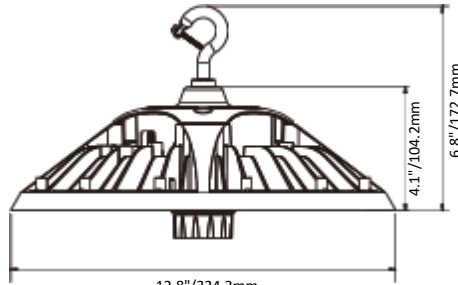

12.8"/324.3mm

Net Weight: 6.6Lbs/3KG

310W

(AC120-277/347V, AC277-480V)

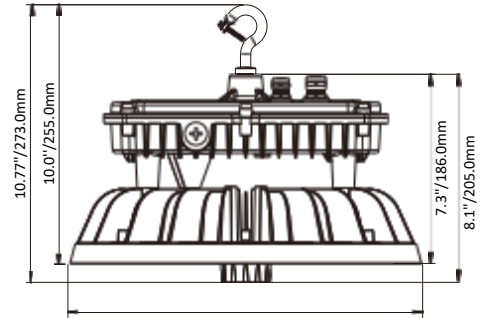

13.8"/350.0mm

Net Weight: 11.5Lbs/5.2kgs

100W/120W/150W

(AC277-480V)

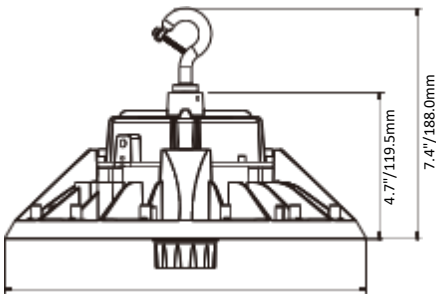

11.6"/294.3mm

200W/240W

(AC277-480V)

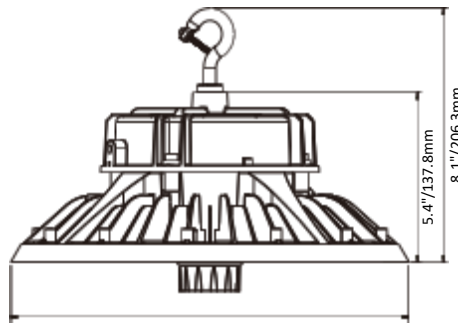

12.8"/324.3mm

Photometrics

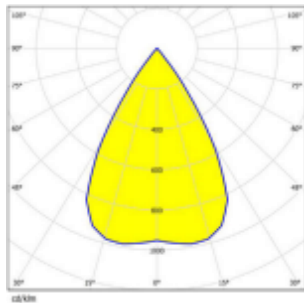

Beam angle: 60°

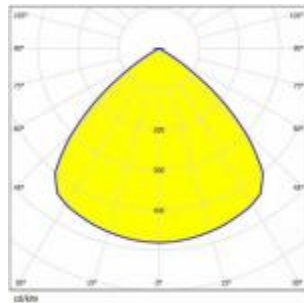

Beam angle: 90°

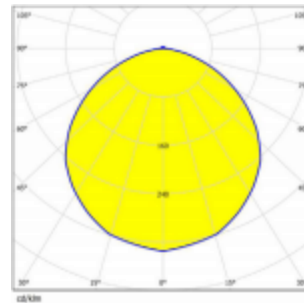

Beam angle: 120°

Accessories

Intelligent control



Daylight sensor



Microwave Moion Sensor



Networking Wireless Control version Microwave Moion Sensor



PIR sensor



Networking Wireless Control version PIR Sensor



Remote controller

Installaion mount



G Hook Mount



O Hook Mount



U bracket



PendantMountAdapter

Reflector

Diff use Aluminum Reflector

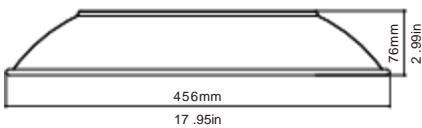

100W, 120W, 150W (150/120/100)W

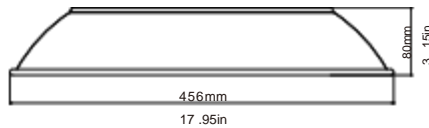

200W, 240W (240/200/180)W
310W, (310/270/240)W



Frosted Polycarbonate Dome Lens

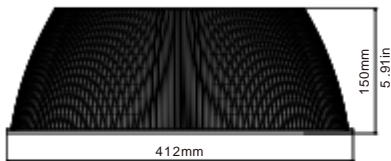

100W, 120W, 150W (150/120/100)W

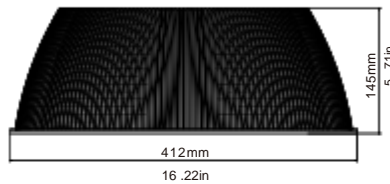

200W, 240W (240/200/180)W
310W, (310/270/240)W



Dust Cover For Frosted Polycarbonate Dome Lens

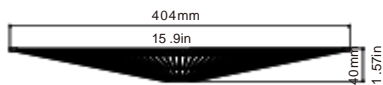

100W, 120W, 150W (150/120/100)W

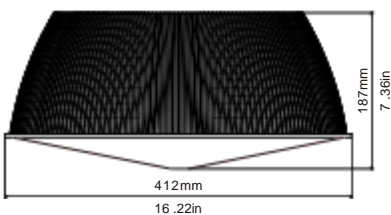

200W, 240W (240/200/180)W

