

Wireless AV Content Sharing & BYOD collaboration System (Quad Viewer)

User Manual_V1.3

Receiver: WU-10

Transmitter: DG-H18(HDMI dongle), DG-C18(Type C dongle), DG-mini(USB Disk)



WU-10 is our brand new wireless conference product that's designed to meet today's hybrid workforce's requirement with not only local presentation but also collaborate with remote participants, it enables people to connect the room camera, mic, speaker and display with their own laptops wirelessly, so people can take advantage of room A/V system to collaborate with both in-room and remote meeting participants, without cable limitation and hassle.

Feature List:

WU-10:

- Pure wireless presentation experience, bring your own device, no cable messy.
- Wireless connection between your laptop and room USB peripherals like camera, mic and speakers for easy video conference.
- Fully compatible with mainstream VC platforms like teams, zoom, webex, etc.
- Wireless content input up to 1080P, HDMI 2.0 output
- Support native wireless mirroring protocols like Airplay, Miracast, Chromecast
- Support plug-n-play HDMI/Type-C/U disk dongles for wireless connection
- Support Windows APP for wireless connection (MAC APP will be available soon)
- Support 4 split screen view
- Support wireless touch back on interactive whiteboard/touch screen
- Best-in-class data security with dual network and high standard encryption
- PoE supported, saving PSU when connecting with PoE ethernet switch
- OSD control with preview function
- Support whiteboard and annotation
- Customizable home screen page

- Central management platform available

DG-mini/DG-H18/DG-C18:

- Can wireless transmit PC's mirror or extended desktop to base unit.
- Quick "Show-me" button to selection switcher the active signal of PC, less than 1s.
- "Show-me" button can independently step in/out the source of PC.
- Dual color LED, green indicates active source signal, red indicates power/link.
- Support USB devices such as USB speakerphone, USB camera over WI-FI sharing.

Version log:

Version	Revise time	Description
1.0	2021, 19 th Feb.	Created
1.1	2021, 30 th Aug.	Updated
1.2	2021.24 th Sept	Updated
1.3	2021.23 rd Dec.	Updated

Catalogue

1. Overview:	8
2. Specification:	11
3. Panel Layout	13
3.1 Hardware Interface	14
3.1.1 WU-10 Front Panel	14
3.1.2 WU-10 Rear Panel	16
3.1.3 Factory Reset	18
3.1.4 Dongle Front Panel	20
3.2 Software Interface	24
3.2.1 Home Screen	24
4. Installation	27
4.1 Installation methods for the Base unit	28
4.2 Wiring Diagram	30
4.3 Power Connection	30
4.4 Video Connection	31
4.5 Audio Connection	32
4.6 LAN connection	34
4.7 Usage of USB device	35

5.	Quick-to-Start.....	37
5.1	Mobile device: Wireless Connection.....	37
5.1.1	Enable portable hotspot:.....	38
5.1.2	Enable LAN connection:.....	39
5.2	Pairing transmitter with base unit.....	40
5.3	Mirroring.....	43
5.3.1	Microsoft Windows PC/Laptop with Dongle.....	43
5.3.2	Microsoft Windows PC/Laptop with application.....	49
5.3.3	Options for Microsoft Windows PC / Laptop – Extended Screen.....	53
5.3.4	MAC OS PC/Laptop with Dongle.....	57
5.3.5	MAC OS PC/Laptop with application.....	60
5.3.6	Operations for Apple MacOS, MacBook – Extended Screen.....	63
5.3.7	Quad view mirroring.....	65
5.3.8	Mobiles Devices.....	66
5.3.9	Miracast on Android Devices and WIN10 PC/Laptop.....	70
5.3.10	Chromecast on PC.....	74
5.4	Preview Window.....	77
5.5	Whiteboard & Annotation.....	78
5.5.1	Whiteboard.....	79

5.5.2	Annotation.....	82
6.	Strat video conferencing via USB-over-WiFi technology.....	85
6.1	Start with DG-mini dongle or PC application.....	85
6.2	Start with HDMI dongle or Type C dongle.....	88
7.	Web Setting Management Configuration.....	92
7.1	Network settings.....	94
7.1.1	Wireless network.....	94
7.1.2	Ethernet.....	108
7.1.3	Auto change password.....	109
7.2	Display & Audio.....	110
7.2.1	HDMI.....	110
7.2.2	Audio.....	113
7.2.3	Airplay screen quality.....	115
7.2.4	Start screen.....	115
7.2.5	Home Screen background image.....	116
7.3	Moderator control.....	117
7.4	System settings.....	119
7.4.1	Buttons:.....	119
7.4.2	Date & Time.....	120

7.4.3	Auto standby.....	121
7.4.4	Language.....	122
7.4.5	Reset.....	123
7.4.6	Configuration File.....	124
7.4.7	Series Port Setting.....	124
7.4.8	Telnet switch.....	125
7.5	Security Settings.....	126
7.5.1	Security level.....	126
7.5.2	Login Password.....	128
7.5.3	Connection password.....	128
7.6	Firmware upgrade.....	129
7.6.1	Firmware Update.....	129
7.6.2	Automatic Upgrading.....	130
7.7	Other settings.....	130
7.7.1	Auto create launcher.....	130
7.7.2	Clear history after meeting.....	131
7.8	About device.....	132
8.	Updating WirelessMedia.....	133
8.1	Check current firmware information.....	133

8.2	Upgrading firmware of base unit:.....	137
8.3	Upgrading and Pairing of Dongle:.....	139
8.4	Upgrading Launcher:.....	140
8.5	Clean left files of older versions of Launcher program in Lap-top.....	143
9.	WIFI Recommendation Setting.....	145
9.1	Check the WIFI config on base unit.....	145
9.2	Check the WIFI RSSI on dongle or Mobiles.....	145
10.	Problem Shooting.....	145

1. Overview:

WirelessMedia

WirelessMedia makes connecting or participate in a meeting by a most simple way, touching a button. It also allows the others to join in the meeting more actively. The result is to make the meeting more efficient and productive.

WU-10 has built-in Wi-Fi module, support for multiple access, including Airplay, Miracast, HDMI dongle, Type C dongle. Users could easily bring their own devices like Mac/Windows laptop/Apple and Android mobile devices to share their contents onto main display wirelessly.

WU-10 supports USB Camera, USB Speak Phone over WI-FI sharing, by connecting external USB devices to base unit and transmits via Wi-Fi, easily configure your meeting room setup, to make video conference more efficiently.

A typical WirelessMedia contains one Base Unit WU-10 and Transmitters e.g. DG-H18 and DG-C18 for choices.

Wirelessmedia Set Components

A typical WirelessMedia Set includes two Buttons, one Base Unit, “WMedia2” for Android” APK and Airplay for IOS”. Depending on the application or size of meeting room, user could purchase more kinds of buttons, e.g. HDMI dongle/ Type C dongle if they need.

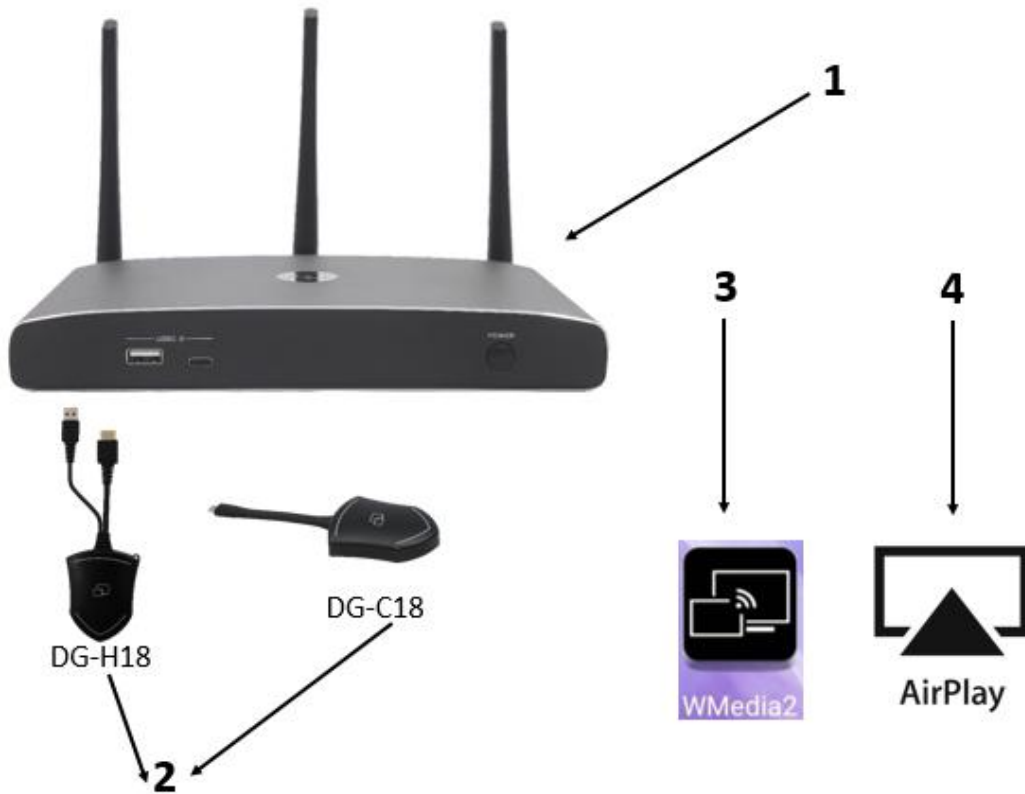

ID	Name	Description
1	Base Unit	Host unit
2	Transmitters	For PC/Lap-top to share the desktop/extended desktop.
3	“WMedia2” App for Android	For smart android devices to share the screen.
4	Airplay for IOS	For smart IOS devices to share the screen.

Accessories List

ID	Name	Description
1	Antenna	3 pcs of antenna are included in the box. To avoid damage, they are not pre-mounted. The antenna can rotate for a better wireless

connection.

WU-10 Specification	
HDMI output	1x HDMI 19-pin female connector
Video Output Resolution	3840x2160@60Hz, 3840x2160@30Hz, 1920x1080@60Hz, 1280x720@60Hz
Format Compliance	HDMI1.4/HDMI2.0
Video Capacity:	1080P @ <60Hz Airplay for IOS devices 1080P @ <60Hz "WirelessMedia2" app 1080P @ <60Hz for all show-me button
HDCP	HDCP1.4/HDCP2.2
Analog Audio Output	1x 3.5mm PC audio female connectors
LAN port	RJ45 x2: 1000Mbps x1, 100Mbps x1
USB interface	USB3.0 x3, USB 2.0 x1, Type-C x2

2	Power adapter	International plug inter-changeable power adapter, of which the plugs includes US, Europe, UK, Australia standard.
3	Phoenix terminal	1 piece phoenix terminal for connecting the RS232 port of the rear panel.

2. Specification:

Audio Input	AirPlay, Miracast, DLNA, Windows/MAC, WMH, USB/BT SpeakPhone
Control connectors	3.5mm Phoenix terminal/ RS232 interface
Number of window simultaneous on screen	≥4+14 (4 main windows+14 thumbnail windows)
Number of simultaneous connections	≥16
Data rate in wireless	Up to 1200Mbps
Video Playback Frame Rate	20–60 FPS
Latency	<100ms, Min 20ms
Wireless transmission protocol	WIFI IEEE 802.11 a/g/n/ac
Frequency band	2.4 GHz & 5 GHz
Dimension (W x D x H)	220mm x 120mm x 41mm (including antenna : 220mm x 120mm x 145mm)
Weight	1.0kg
Temperature	-4° ~ +140° F (-20° ~ +60° C)
Humidity (Storage / Operating)	20%–90% (non-condensing)
DC Power	12V / POE
POE standard	IEEE802.3af
Power Consumption	10W(MAX)

3. Panel Layout

About this chapter

The installation chapter gives an overview of the interface of WirelessMedia.

Overview

- Hardware Interface
 - WU-10 Front Panel
 - WU-10 Rear Panel
 - DG-H18/DG-C18 Front panel
- Software Interface
 - Home Screen

3.1 Hardware Interface

3.1.1 WU-10 Front Panel

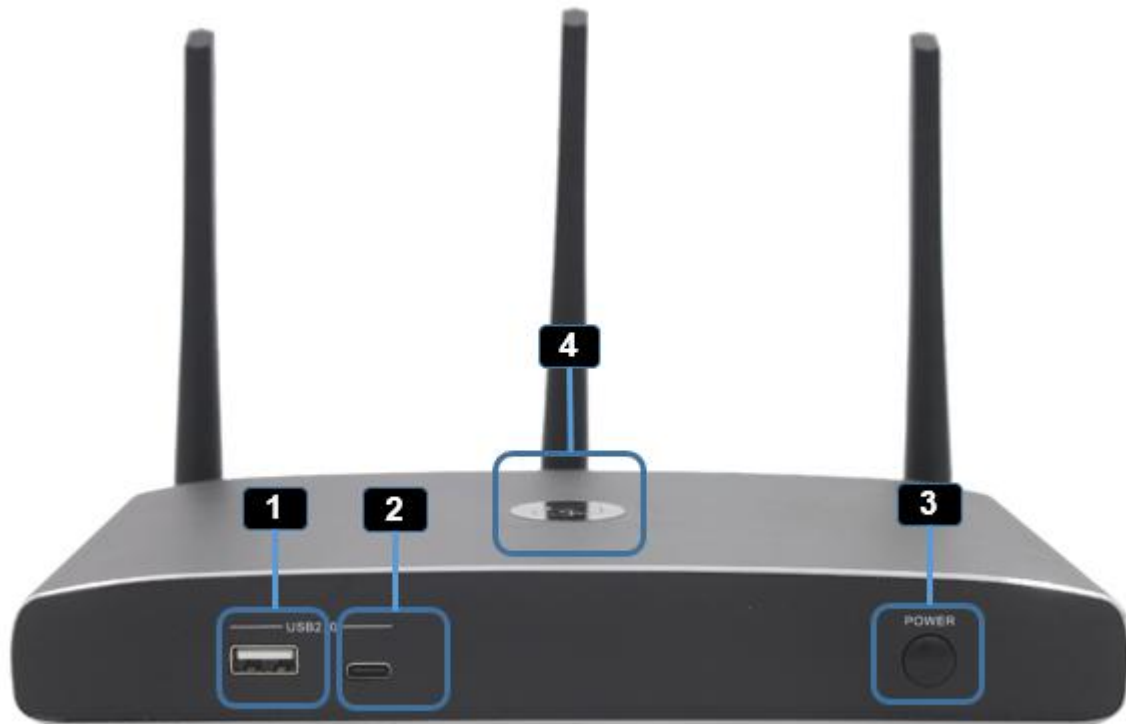

Note: Front USB port and type C port cannot be used in the same time, type C port is prior to USB port.

ID	Name	Description
1	Front USB connector	USB port, for dongle pairing, mouse control, USB touch screen etc.

2	Front Type-C connector	Type-C port, for dongle pairing.
3	Power Button	Turn on or off the device.
4	Back-lit LED indicator	Initializing indicates RED, power on indicates flashing GREEN, "Ready to share" indicates static GREEN, "Sharing" indicates static cyan.

USB port

- The USB port is used to update the software of the WU-10.
- The USB port is used for pairing the dongle and base unit, when the transmitter is plugged-in.
- The USB port is used for connecting a mouse to create/upgrade Launcher by clicking **Download** button, hide SSID, PASS, Wifi IP and Lan IP by clicking **Info**, check **Security level button** and control PC source device, when a PC desktop is mirroring to the screen by plugging in the dongle.
- The USB port is used for connecting a USB-based touch screen to create/upgrade Launcher by clicking **Download** button, hide SSID, PASS, Wifi IP and Lan IP by clicking **Info**, check **Security level button** and control PC source device, when a PC desktop is mirroring to the screen by plugging in the dongle.
- The USB port is used for creating or upgrading Launcher by clicking **Download** button, when a USB stick is plugged in.

Type-C port

The Type-C port is used for pairing Type C dongle with base unit.

Mechanical fixture points.

The mechanical fixture points are located at the bottom of the base unit.

3.1.2 WU-10 Rear Panel

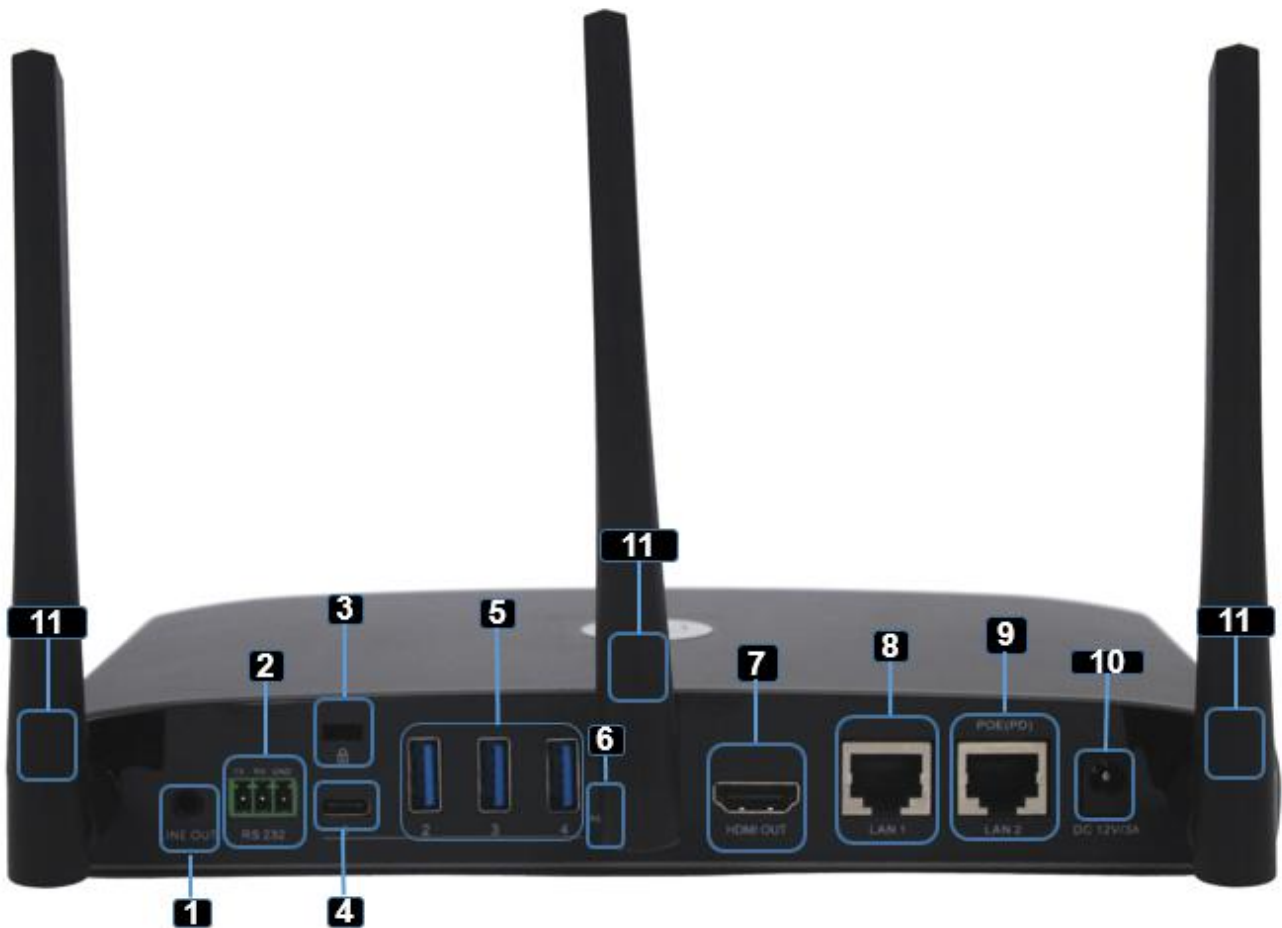

ID	Name	Description
1	Line audio output	2 channel analog audio output, Connect a 3.5mm mini-jack PC connector from this jack to the Line in jack of an audio system.
2	RS-232	Connect an RS-232 cable from this port to an RS-232 device.

3	Kensington Lock	One end is wrapped around a fixed object and one end insert into this port to keep safety.
4	Rear Type-C connector	Type C port, for type C dongle pairing.
5	Rear USB3.0 connector	USB port, for HDMI dongle pairing, mouse control, USB touch screen and USB device such as USB camera and speaker connecting etc.
6	Reset	Reset button to restore to the factory default setting.
7	HDMI output	Connect an HDMI cable from this port to an HD or 4K/HDMI2.0 display.
8	LAN Ethernet port 1	100Mbps, Connect an Ethernet cable between this jack and a LAN to connect WU-10 to LAN.
9	LAN Ethernet port 2	1000Mbps, Connect an Ethernet cable between this jack and a LAN to connect WU-10 to LAN. Support POE.
10	DC Power socket	Connect the included power adapter to this socket, and connect the plug to an available electrical outlet.
11	Antenna fixture points	Screw up the included three antennas to these three ports.

USB port

- The USB port is used to update the software of the WU-10.

- The USB port is used for pairing the dongle and base unit, when the transmitter is plugged-in.
- The USB port is used for connecting a mouse to create/upgrade Launcher by clicking **Download** button, hide SSID, PASS, Wifi IP and Lan IP by clicking **Info**, check **Security level button** and control PC source device, when a PC desktop is mirroring to the screen by plugging in the dongle.
- The USB port is used for connecting a USB-based touch screen to create/upgrade Launcher by clicking **Download** button, hide SSID, PASS, Wifi IP and Lan IP by clicking **Info**, check **Security level button** and control PC source device, when a PC desktop is mirroring to the screen by plugging in the dongle.
- The USB port is used for creating or upgrading Launcher by clicking **Download** button, when a USB stick is plugged in.

3.1.3 Factory Reset

- Start up the Base unit.
- When the *Home Screen* is shown up, press the reset button at the rear panel of base unit. Press this button with a pointed object, e.g. an unbent paper clip until the “*Factory Reset*” page is shown up as below, for at least 2 seconds.
- The Base unit will reboot after 3 seconds to be default configuration.
- If you do not have a picture, press and hold the reset button until the red LED in the top panel will lit, to execute the reset.

All previous settings will be lost and you will need to do the set-up once more.

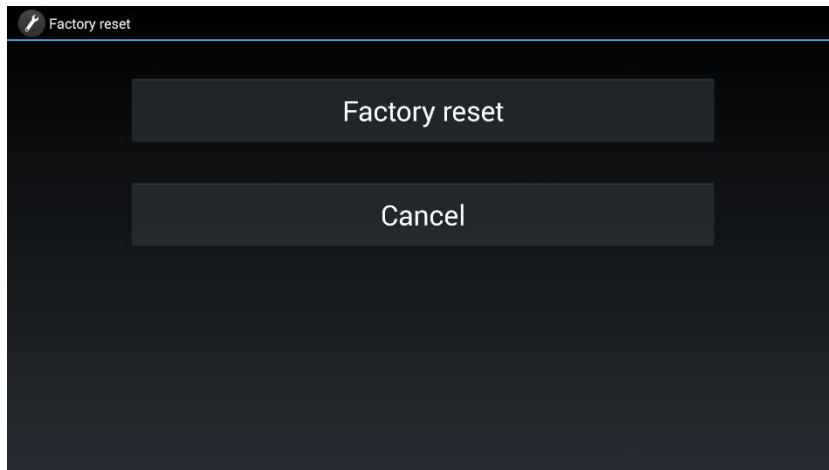

Default Configuration

- Ethernet:
 - Proxy: None
 - DHCP: Enable
- Wireless network:
 - Frequency: 5GHZ
 - Channel: Auto
 - Auto change Wi-Fi hotspot password: 5minute
- Display & Audio
 - HDMI resolution: Auto
 - HDMI CEC:
 - ◆ Device auto power off: ON
 - ◆ Base unit auto power on: OFF
 - Audio output: Jack&HDMI
 - Airplay screen quality: High

- show device name and password when mirroring: OFF
- show PCs user name when mirroring: ON
- Moderator Control
 - Add a sub-window bar to enable previewing the connected devices: ON
 - Real time preview: ON
- System settings
 - Date & time: Automatic date & time: use network-provided time
 - Auto Standby: Never
 - Language: English
- Security Settings
 - Security Level: Security level 1
 - Connection Password: 4-digits password beginning with 0000
 - Change admin password: admin(default)
- Other settings
 - Auto create launcher: Disabled
 - Clear history after meeting: Always

3.1.4 Dongle Front Panel

DG-mini, DG-H18, DG-C18 are dongles, which is used for toggling the mirroring from personal PC or MAC desktop on the main screen.

LED ring indicator behavior

- When LED indicator is static green, it's ready to mirror your PC desktop on the main screen.
- When LED indicator is static red, 1) it's mirroring your PC desktop on the screen, 2) pairing is done. You can now unplug the Button from the base unit.
- When LED indicator is blinking Green, it indicates 1) the button is plugged in the laptop and initializing or waiting for user to start the WirelessMedia application, 2) pairing/software upgrading of the button in the Base Unit is in progress.
- When LED indicator is Off (no light), it indicates 1) the button is not plugged in the PC/Lap-top; 2) the button is defective; 3) the USB port or computer might be defective.

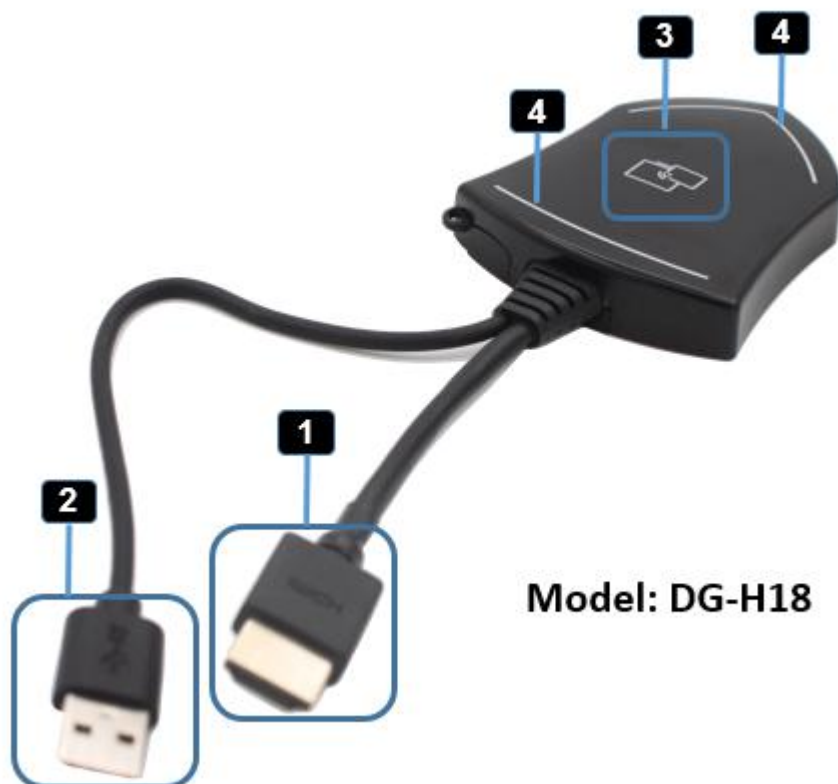

ID	Name	Description
1	HDMI connector	Using HDMI connector of the button can be plugged into a PC/Laptop for sharing your screen.
2	USB connector	Supply power, or plug into the base unit for pairing the Button to the Base Unit or upgrade the dongle.
3	Touching Button	Touch the sensor button to start displaying the content of the PC/Lap-top's screen on the main screen. Touch the button during the meeting will toggle the sharing of the screen.
4	LED ring indicator	Indicates the status of the button.

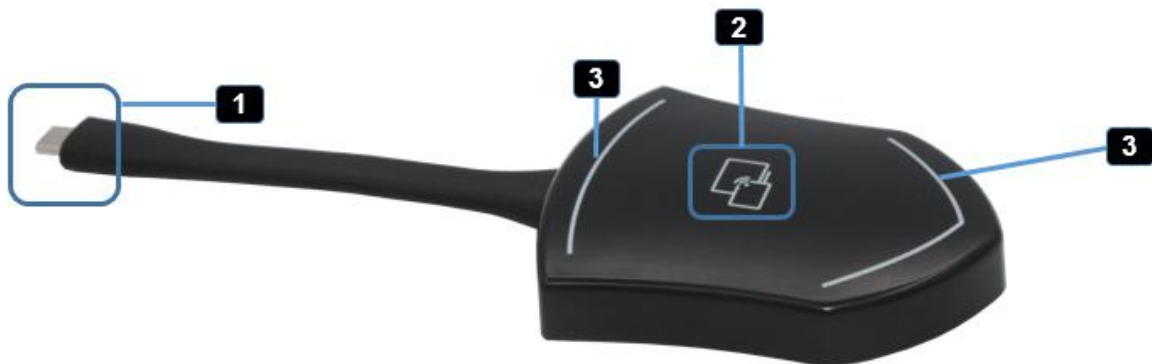

Model: DG-C18

Note: DG–C18 is full function type–C interface with DP Altmode inside, which supports Audio and video transmission. Thus PC’s type C connector also requires full function type C connector for mirroring screen.

ID	Name	Description
1	Type C (DP) connector	Using Type C (DP) connector of the button can be plugged into a PC/Laptop for sharing your screen.
2	Touching Button	Touch the sensor button to start displaying the content of the PC/Lap-top’s screen on the main screen. Touch the button during the meeting will toggle the sharing of the screen.
3	LED ring indicator	Indicates the status of the button.



DG-mini

ID	Name	Description
----	------	-------------



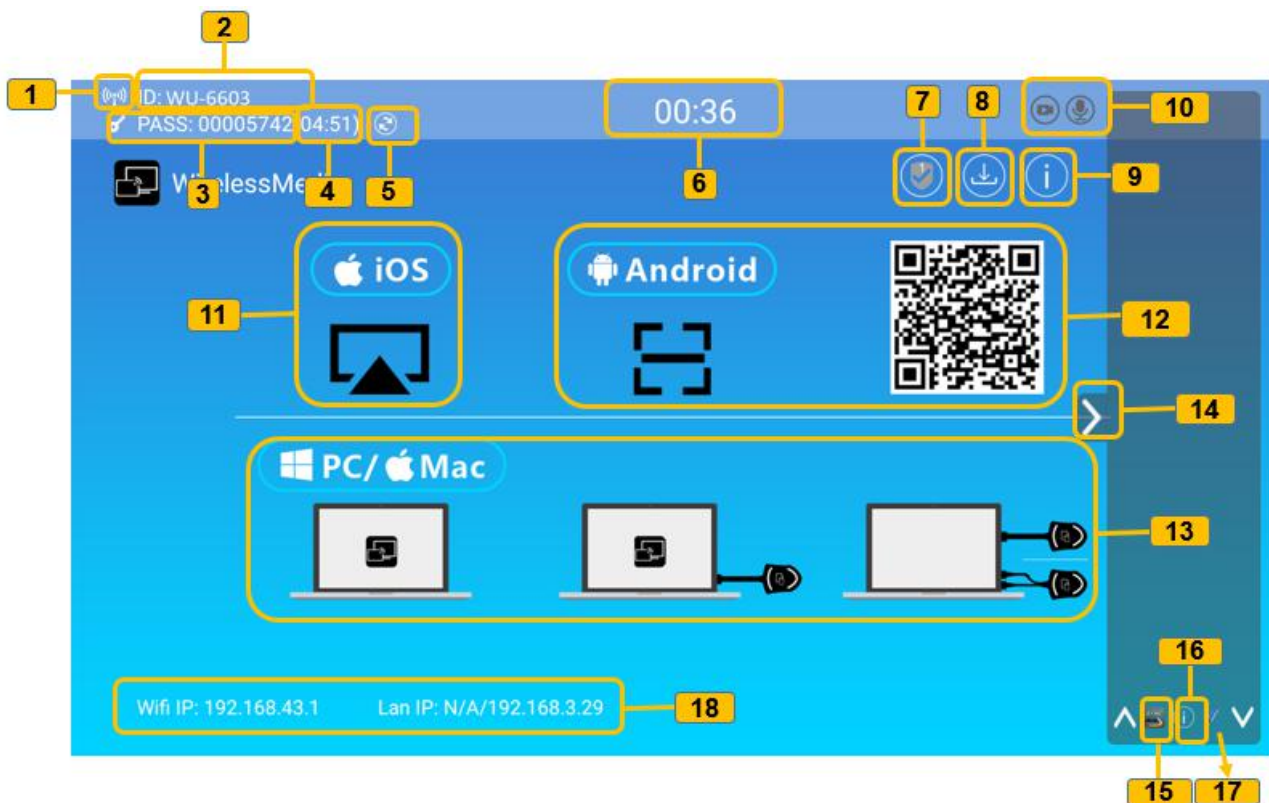

1	USB connector	Using USB connector of the dongle can be plugged into a PC/Laptop for sharing your screen.
2	Type C connector	Using Type C connector of the dongle can be plugged into a PC/Laptop for sharing your screen.

3.2 Software Interface

3.2.1 Home Screen



ID	Name	Description
----	------	-------------

1	Wi-Fi Indicator	<p>Wi-Fi Direct mode: internal access point is enabled </p> <p>Wi-Fi Infrastructure mode: “Client-Mode“ , </p> <p>Wi-Fi connection to router is established, icon displays the current signal strength.</p> <p>A secure Wi-Fi connection is established, or connection to a router failed: </p> <p>Wi-Fi is not available: </p> <p>LAN Infrastructure mode: access point is disabled</p>
2	ID	Wi-Fi name or device name of the Base-unit access point.
3	PASS	Wi-Fi password of base unit.
4	Password-timer	only displayed, when timer is active; time until the password is changed automatically.
5	Refresh Wi-Fi-password	Generate new password manually for securing your Wi-Fi network.
6	TIME	Show time, if LAN has access to a time server; even after disconnecting the LAN connection, the time is

		displayed until the device has been disconnected from power.
7	Security level	Security level 1–3, display ONLY; the security features of the displayed level are displayed in detail by clicking on the icon; the settings can only be changed by administrator in the webserver console setting menu.
8	Download Button	Creating & upgrading Launcher “WirelessMedia.exe“ for Windows, MAC to USB stick.
9	Info	Show status–bar (1) – (7) in Home screen showing/hiding
10	Camera and microphone icon indicator	Once WU–10 connected with USB camera or microphone, the icon will show up accordingly.
11	IOS quick start	IOS devices use Airplay for mirroring.
12	Android Quick Start	Scan QR code to download android app “WMedia2” to mirror from smart devices to display.
13	Windows / MacOS Quick Start	Steps to instruct how to transmit PC/Lap–top onto the main screen. First–time users must first install the starter program from the web page or from the USB stick one time.

14	Preview function of the screen contents of the participants with transmitter and mobile devices; White Board& Annotation function icon	Preview function of the screen contents of all connected transmitters and mobile devices; White Board and Annotation function.
15	Whiteboard icon	Whiteboard function
16	Info	Click to show ID and password when mirroring.
17	Annotation	Annotation function.
18	Wi-Fi IP LAN IP	<ul style="list-style-type: none"> ● Wi-Fi IP: address of base unit in wireless LAN ● Assigned IP: address of base unit in LAN; <p>“N/A“ = no connection to network</p>

4. Installation

The installation chapter gives an overview of the different ways to install and connect WirelessMedia Base Unit.

Overview:

- Installation methods for the Base unit
- Table mounting

- Wall mounting
- Recommendations about antenna placement and orientation
- WU-10 Power Connection
- WU-10 Video Connection
- WU-10 Audio connection
- WU-10 LAN connection
- About USB device connection
- Wiring Diagram

4.1 Installation methods for the Base unit

Introduction to the installation methods:

The Base unit can be installed in different ways in a meeting room.

- Table mount
- Wall mount

The articulated antennas are removable. They can rotate for better wireless connection.

Attention: For optimal performance, install the Base unit close to the display and avoid obstacles between the Base unit and the Transmitters.

Necessary tools

- A drill (type of drill depends on the type of wall)

- The mounting screws (mounting screws not included in the package)

Necessary parts

- 2 mounting screws (Screw head diameter of screws shall be within 6–8mm)

How to install

1. Drill two holes in the wall as indicated on the drawing.

Horizontal distance: 177 mm ± 0.15

2. At the bottom of Base Unit, turn in 2 flat screws into 2 holes of its smallest diameter to be fasten enough.

Note: Mounting screws are not included in the WirelessMedia box . The type of screws depends on the type of wall (stone, wood, plasterboard, ...) you are mounting the Base Unit to. Make sure the head of the screw is not larger than the hole in the bottom of base unit.

3. Place the WU-10 on the wall and fixate the base unit with the 2 screws.

Antenna placement rules

- The antennas should be oriented vertically, so perpendicular to the ceiling and parallel to the walls.
- The antennas should be installed far enough (at least 50cm/1.6ft) from metallic surfaces to avoid unwanted reflections and far enough (at least 1m/3.3ft) from other radio equipment that operates in the same frequency range, e.g. other Wi-Fi access points, cordless telephone, microwave ovens,.... It is also best to install antennas at least 15 cm (6 inches) from concrete walls.

- The most favorable situation is a direct line of sight between antennas and Buttons. Any obstruction will cause the signal to follow a longer propagation path, which can result in performance degradation.
- Due to the particular radio pattern of the dipole antennas, the antennas should not be placed just above potential positions of WirelessMedia users. As a result, the advised position for the antennas is at the side of the meeting room.

4.2 Wiring Diagram

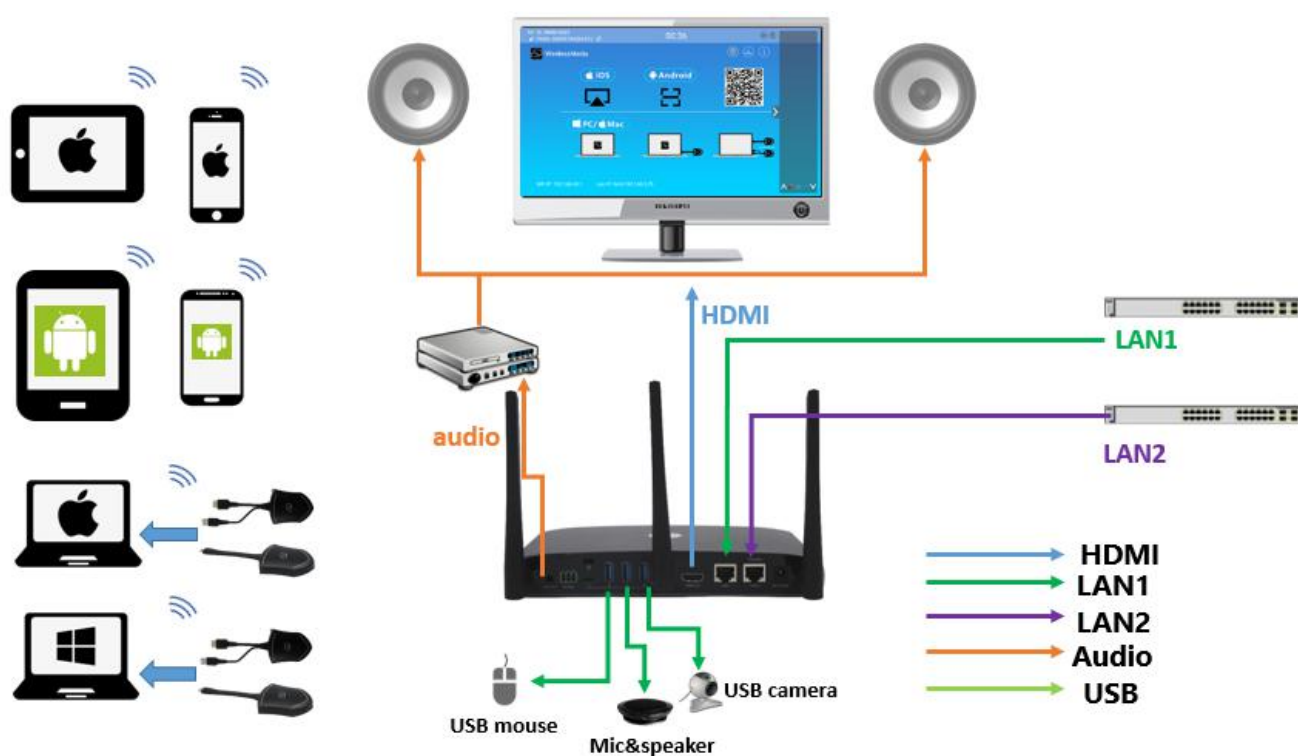

4.3 Power Connection

The Base unit can be powered by the external universal power adapter.

How to connect the external power adapter

1. Plug the power connector to the power adapter to the power input connector of the Base Unit
2. Choose the appropriate power plug (US, UK, EU or AU) to be installed on the power adapter,
3. Connect the power cable plug into the wall outlet.

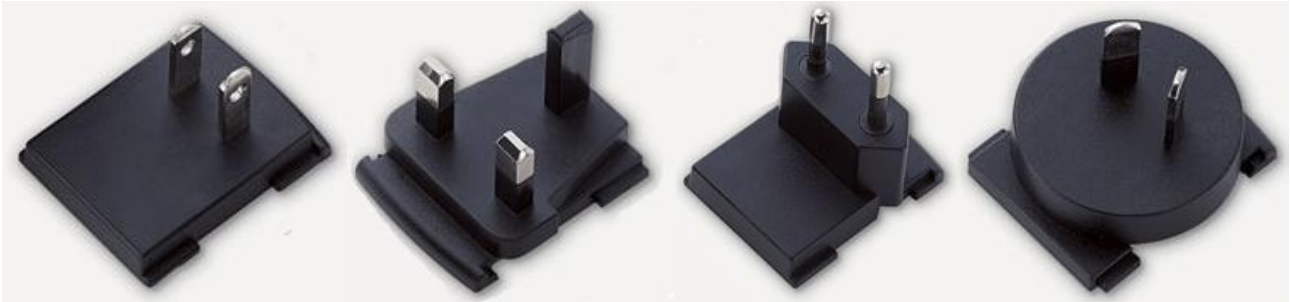

Note: Once the base unit is powered, it starts up. From now on please use the **POWER** button with **Status LED** on front of Base-unit to switch **ON** or **OFF**.

Power over Ethernet

If the LAN Ethernet switcher support POE (Power over Ethernet), it could power up the Base-unit instead of using the external power adapter. (WU-10 LAN2 Port is support POE.)

4.4 Video Connection

1. Connect the **HDMI Output** of base unit to a 4K or Full-HD display by a HDMI cable.
2. Connect the power adapter to the base unit **DC power socket** and connect the other side plug to an available electrical outlet and switch the base unit on.
3. After started, the system show the **home page**, as shown below.

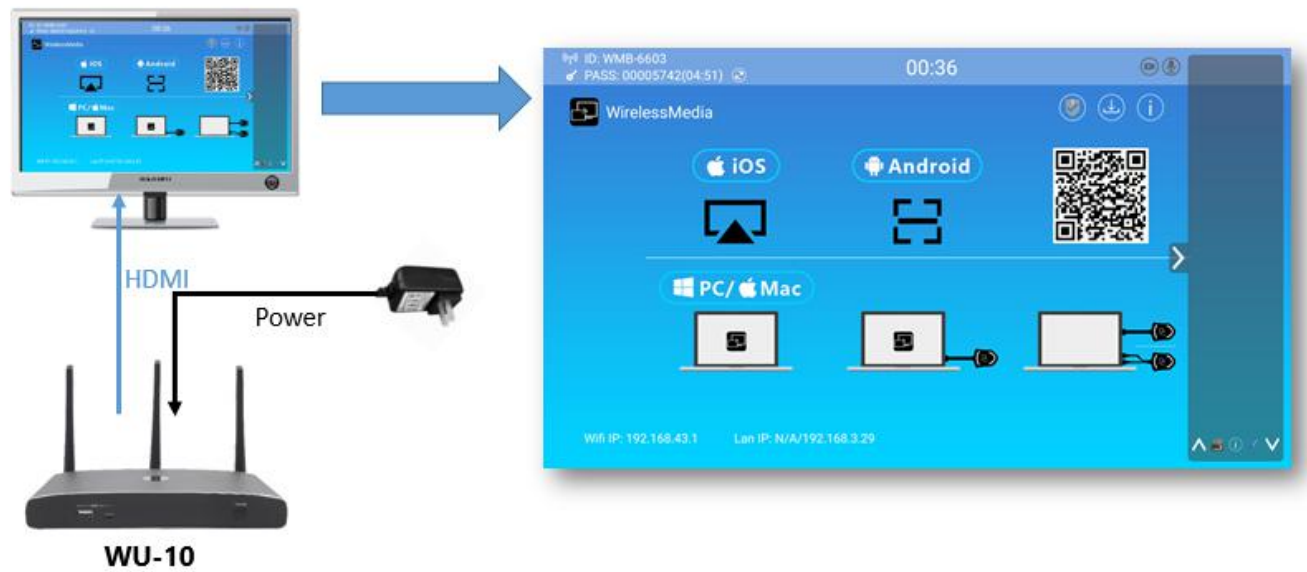

4.5 Audio Connection

WirelessMedia transmitter can transmit the audio output of the PC/Lap-top, re-direct and send to the Base Unit together with the video signal. The audio will be output at line levels from mini jack socket 3.5mm connector and via the HDMI output connectors simultaneously.

It's up to the user to decide whether or not to send the audio signal together with the video signal.

How to connect separate audio

1. Connect an audio cable with mini jack socket 3.5mm connector into the audio of the Base Unit
2. Connect the other side to the meeting room's sound system.

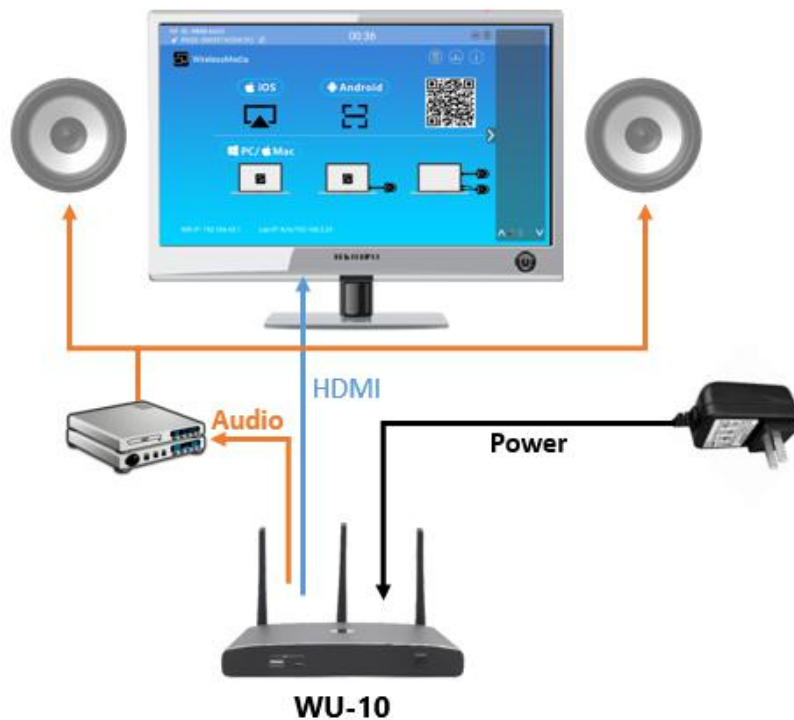

Sound is not sent out

WirelessMedia button will keep capturing and send the audio of PC/Lap-top, since PC/Lap is successfully mirroring desktop to the main screen.

1. Please be sure the button is static green and the PC/Lap-top is sharing on the screen
2. Check *Setting* configuration, to adjust the *Volume* set in *WirelessMedia setting* tab.

PC/Lap Sound

As default set, WirelessMedia will mute the internal speaker of PC/Lap and route the audio to the base unit, after PC/Lap is successfully mirroring desktop to the main screen, in order to avoid the repeated audio.

When click the button to stop sharing, local loudspeaker will return to previous status, you could adjust the volume on your PC/Lap.

Note: If you want to keep the internal speaker of PC/Lap still while route the audio to the base unit, please

click the audio mute icon in the status bar to turn on the internal speaker.

4.6 LAN connection

The Base Unit can be connected to a local network or directly to a PC/lap-top. For normal operation, a LAN connection is not necessary. When needed, it's suggested to connect the WU-10 to the Internet.

1. Connect a network cable with RJ-45 connector into the LAN port of Base Unit.
2. Connect the other side to LAN.
3. If the LAN Ethernet switcher support POE (Power over Ethernet), it could power up the WU-10 than using the external power adapter.

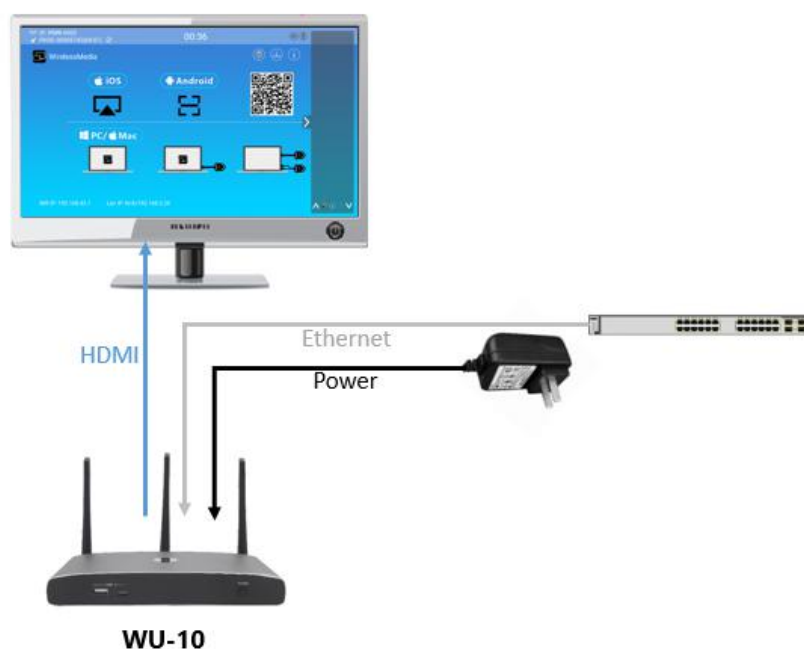

The LAN connection can be used for:

- Network integration of Base Unit in guest or company network.

- Telnet control the Base Unit.
- Maintenance purpose.
- Over-The-Air –Update (OTA) of firmware of Base-unit.

4.7 Usage of USB device

Please use a USB Mouse or Touchscreen.

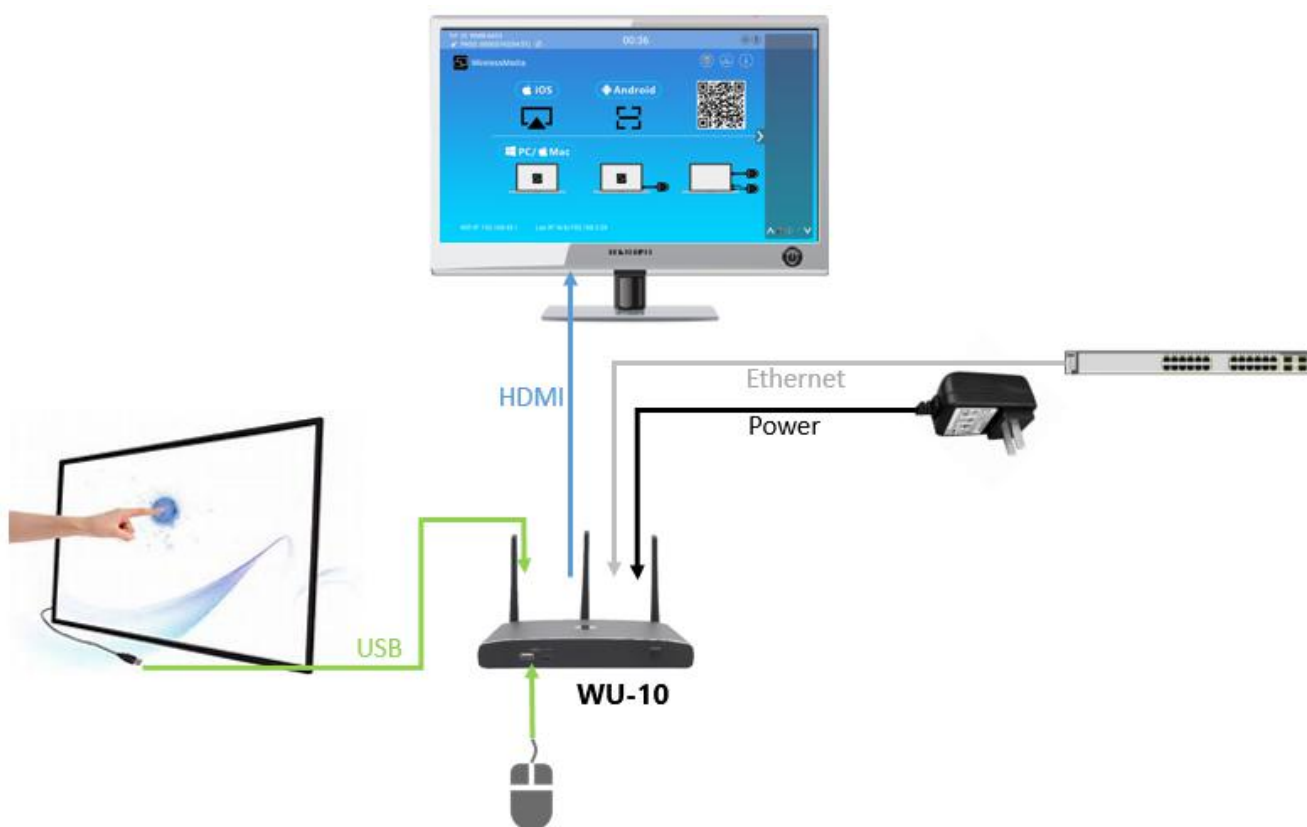

1. To configure the **Security level check button, DOWNLOAD BUTTON, INFO.**
2. To control the sharing PC/Lap-top.
3. To activate system upgrading
4. For white board or annotation during a presentation, WirelessMedia transmits Video, Audio and the USB-HID

function for mouse-control and click-function of a touchscreen. Connect touch-interface of your screen to the USB-port on your laptop or PC.

USB control

USB mouse

- For configuration menu
- Single click to select.
- Right-click to back to the Home Page.

Touch screen

- Click to select.
- Long press to open the contextual menus, as double-click or click the right button of a USB mouse.

External USB Devices over Wi-Fi Sharing

WU-10 support USB Camera, USB speakerphone over wifi sharing.

3 USB port and 1 Type C port in rear panel for connecting the external USB devices such as Microphone, camera... to start meeting with all kinds of video conference software such as Skype, Zoom...

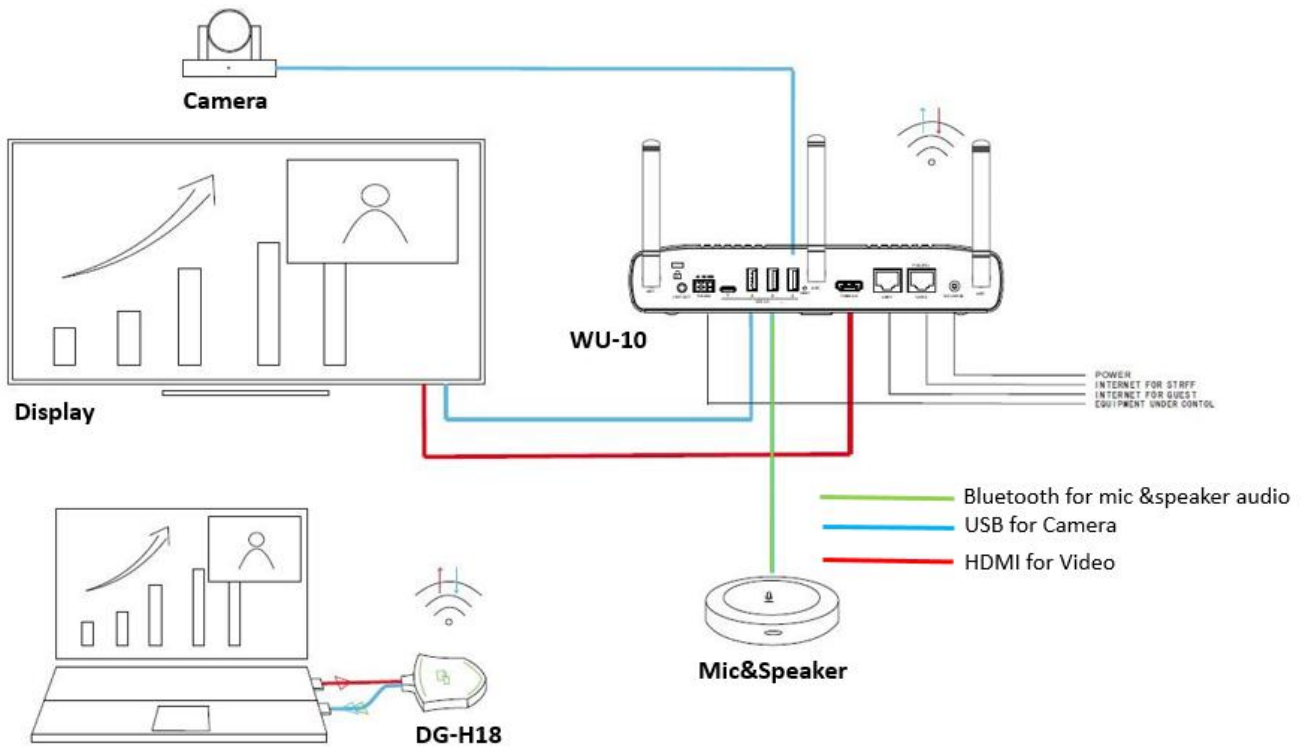

5. Quick-to-Start

5.1 Mobile device: Wireless Connection

1. Download the application namely “WirelessMedia2” (for example scan QR-Code in Home screen) in Android Google Play market for Android mobile device.



2. For IOS devices, use Airplay to mirror the desktop.
3. WirelessMedia provides two way to discover the WU-10 for mobile devices.
 - a) Portable hotspot, to connect the hotspot to connect the WU-10.
 - b) LAN connection, to connect the WU-10 and mobile both in LAN network, to discover and connect to WU-10.

After Factory reset, WirelessMedia starts in standard configuration "Wireless Direct Mode" ("Linked Single Network"), where the base unit creates its own wireless access point, to which all the transmitters connect. This is typical for quick setup, temporarily installations or for small business meetings with a small number of meeting rooms.

The Wi-Fi icon  for "WiFi Direct Mode" appears in the top status bar of the Home screen. The SSIDs for these hotspots appear in the Start screen of WirelessMedia:

Guests and staff have access to the internet when LAN is enabled.

5.1.1 Enable portable hotspot:

Check the ID and PASS (Password) are shown on the Homepage, as shown below.



5.1.2 Enable LAN connection:

Be sure the WU-10 is connected to the Network. When *Local IP* shows an active IP address, such like 192.168.3.29, it indicates WU-10 is successfully connected to the LAN and get an appointed IP address.



Note: When it shows “N/A”, means the WU-10 is not connected to the LAN (Local Area Network) by CAT cable or it failed to get an available IP address by the corporation router.

Please refer to the LAN-settings in Ethernet, as below.

Default password for entering the Main menu on webserver console is “admin”.

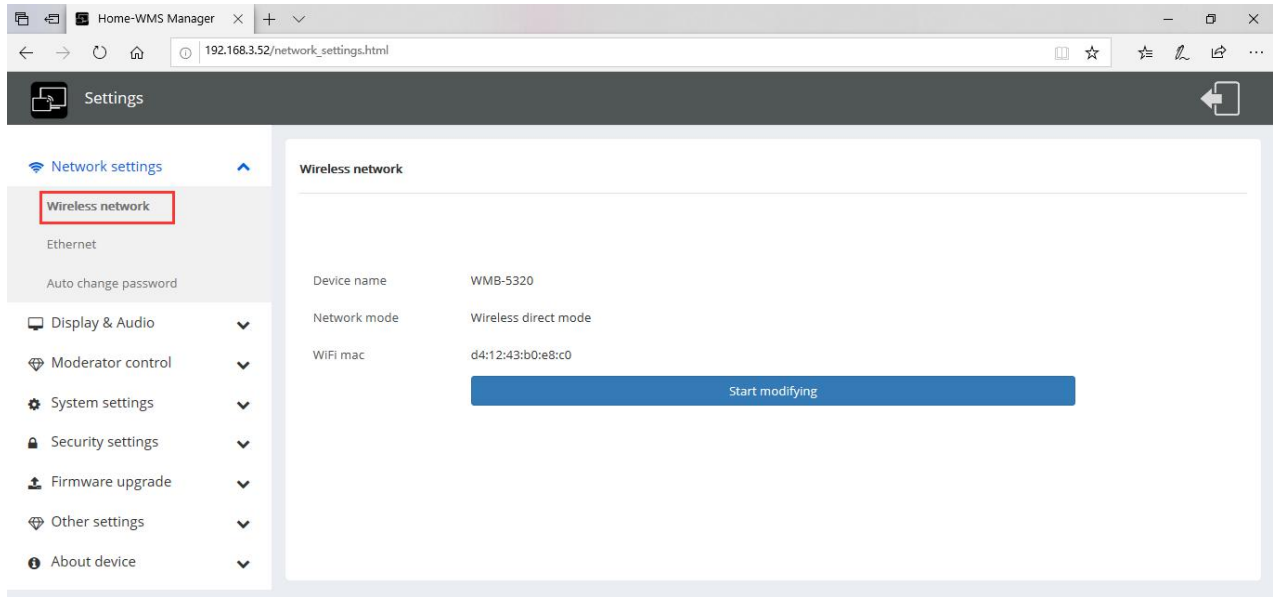

5.2 Pairing transmitter with base unit

1. Connect the DG-mini to USB port/type C port, connect DG-H18 (HDMI dongle)to USB port, connect DG-C18(Type C dongle) to type C port, to pair all the transmitters with base unit. The home page displays as shown below.



2. When plug in transmitters, the message table shows “Dongle is booting, please wait...” as shown below

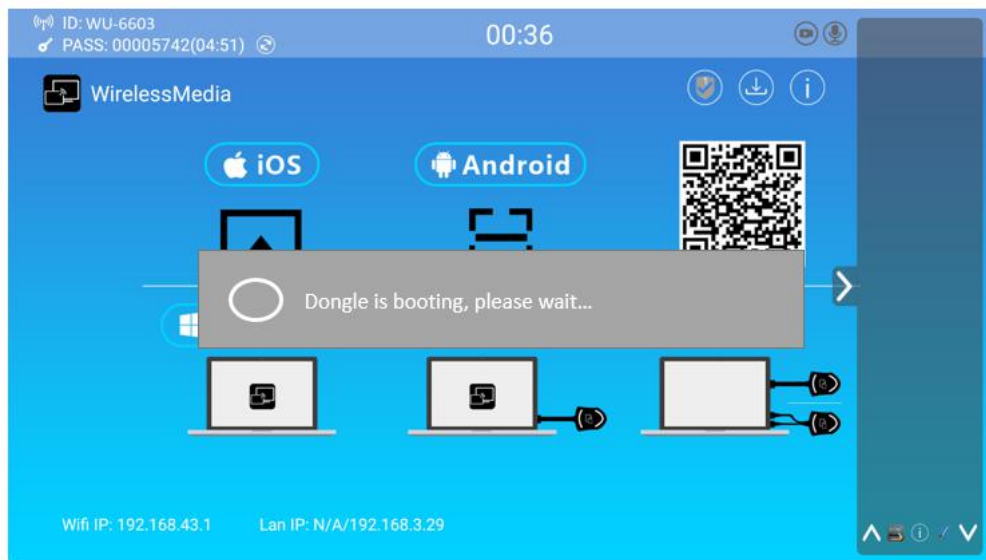

3. Then, the message table shows “Pairing, please wait...” as shown below



4. After completing the pairing, the message table shows “Succeeded to pair!” on the home page, as shown below. Then, please un–plug the transmitters and use it for the mirroring on your laptop.



If error–message “Configuration fail” is shown, please check the connection of USB/type C to keep stable after plug–in, and try again.

Note: After each changing the SSID/Wi–Fi channel in menu, all the transmitters must be paired again!

When you buy additional transmitters or when a transmitter should be assigned to another Base–unit, the transmitter must be paired again.

A transmitter can only be paired to one Base-unit at a time. The transmitter will always make connection to the Base-unit it was last paired to.

5.3 Mirroring

5.3.1 Microsoft Windows PC/Laptop with Dongle

You can operate WirelessMedia for Windows optionally **with Dongle** or **PC Application**. If there are several participants in a meeting, mixed operation is also possible.

Operating system requirement: Windows XP/Vista/7/8/8.1/10 32 & 64 bit.

DG-mini:

1. Plug DG-mini into USB/Type C port to pair with base unit. The “WirelessMedia-windows.exe” for windows PC/Lap-top, “WirelessMedia-macOS.app” for Macbook will be auto downloaded into DG-mini after paring mini dongle to WU-10.

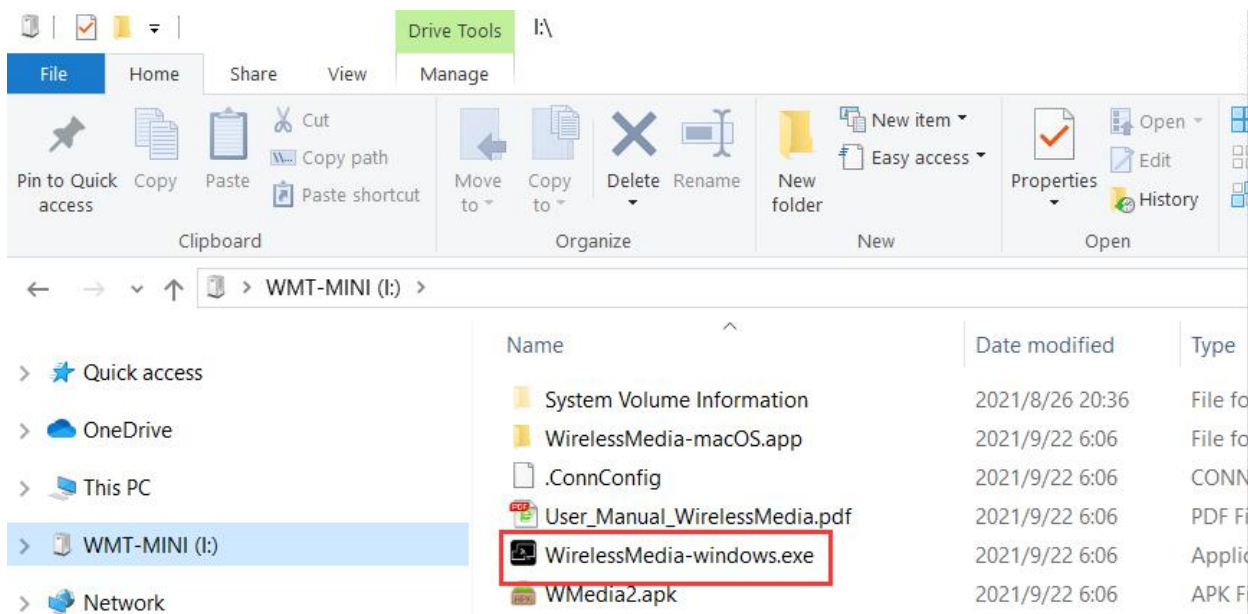

2. Plug DG-mini into PC/Laptop/MACbook and click the “Launcher” to run. DG-mini will auto change PC’s wifi to the target base unit wifi. No need to manually change PC’s wifi. It will pop out the message bar to enter the password to connect.



3. It will show “Ready to share”, click to share the desktop to screen.

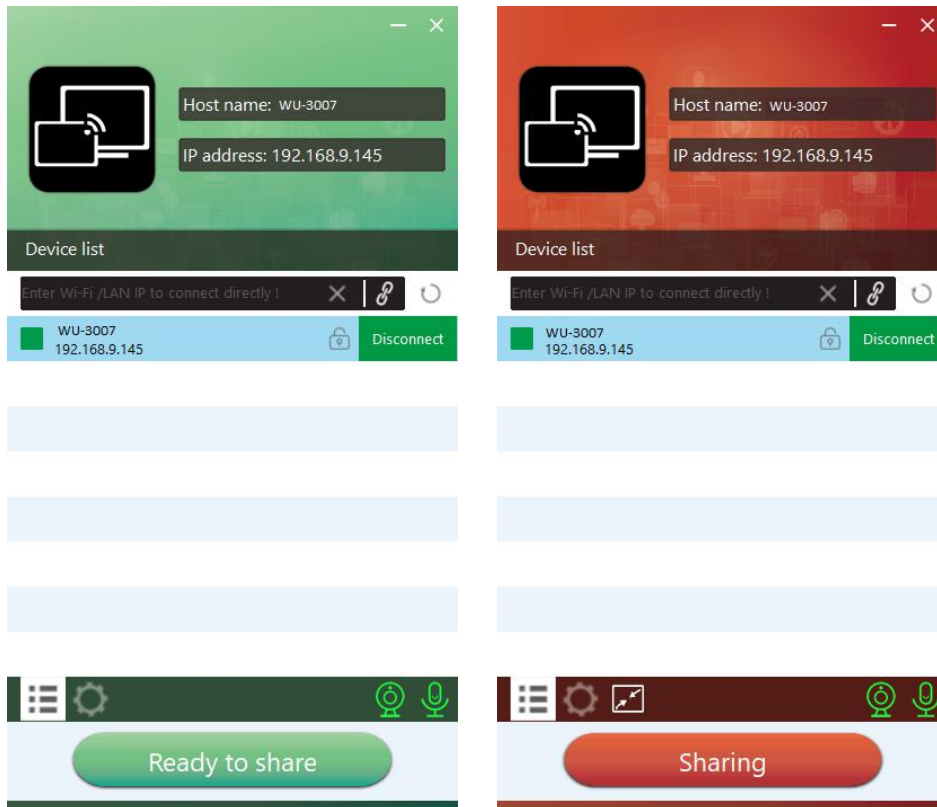

Note: for second time user, DG-mini will automatically run to share screen, no need to click “Launcher”.

Note: The below virtual driver installation guide is also applied to software application, HDMI and Type C dongle usage.

The first time user connects laptop with WU-10 over wifi, when the application detects WU-10 is connected with camera, mic&speaker, it will pop out the message bar indicating to install a virtual driver to activate USB over wifi function, in order to start video conferencing via WU-10, as below steps.

The virtual driver is only for video conferencing, user can normally mirror desktop without it installed. If the WU-10 is not connected with camera, mic&speaker, it will not pop out message to install driver, user could mirror desktop as well.

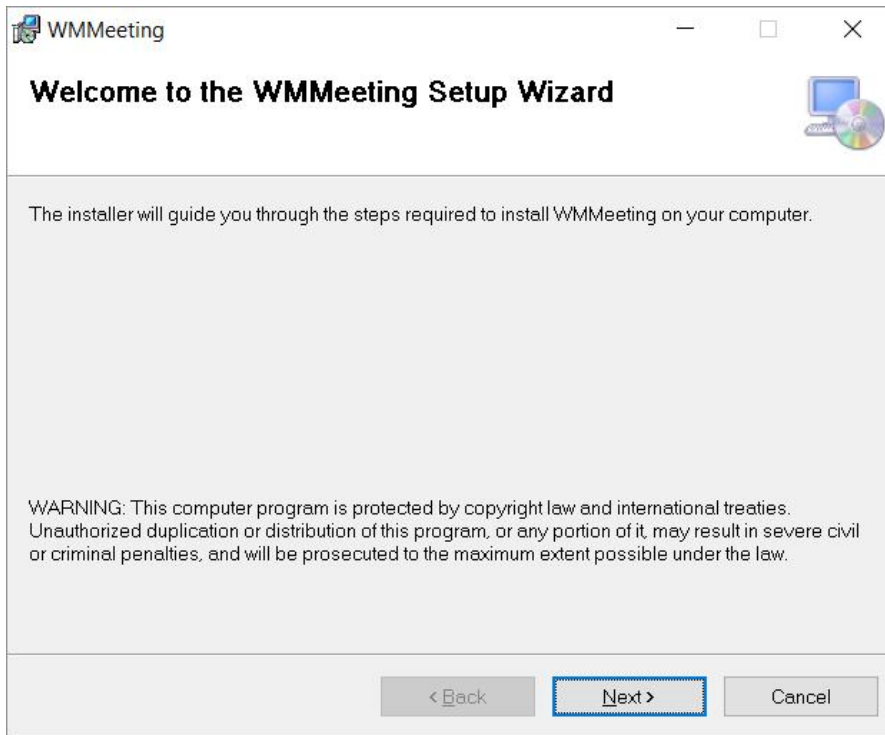
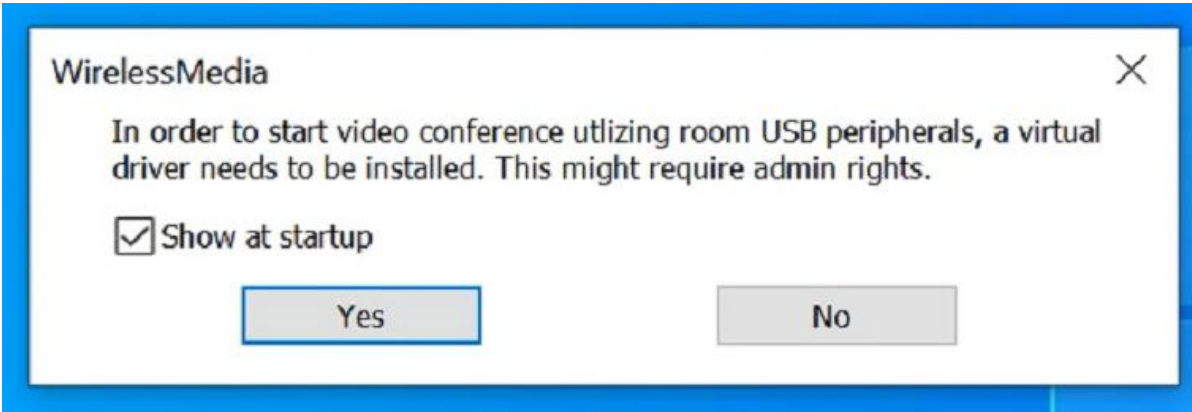

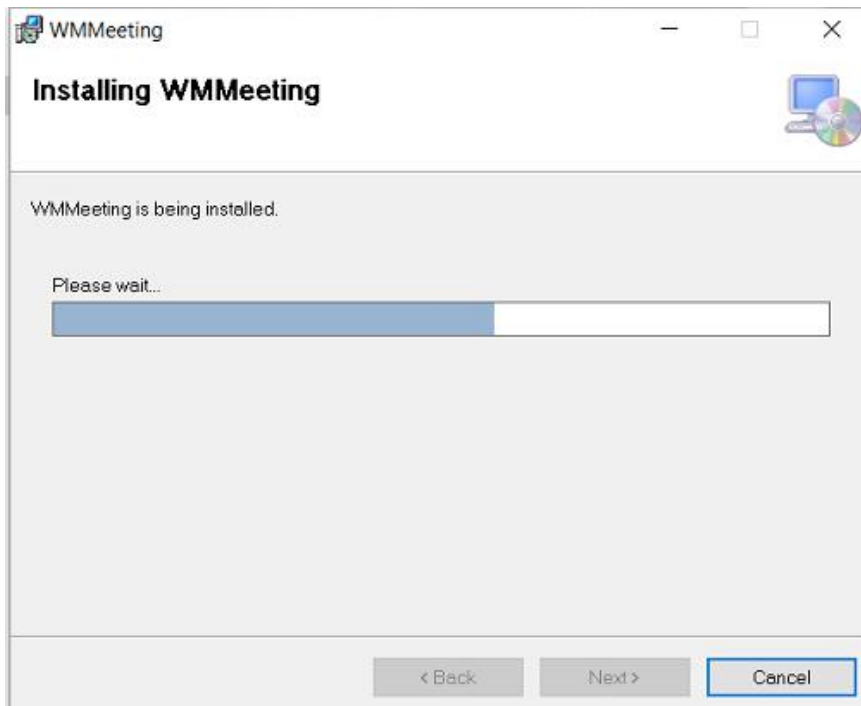
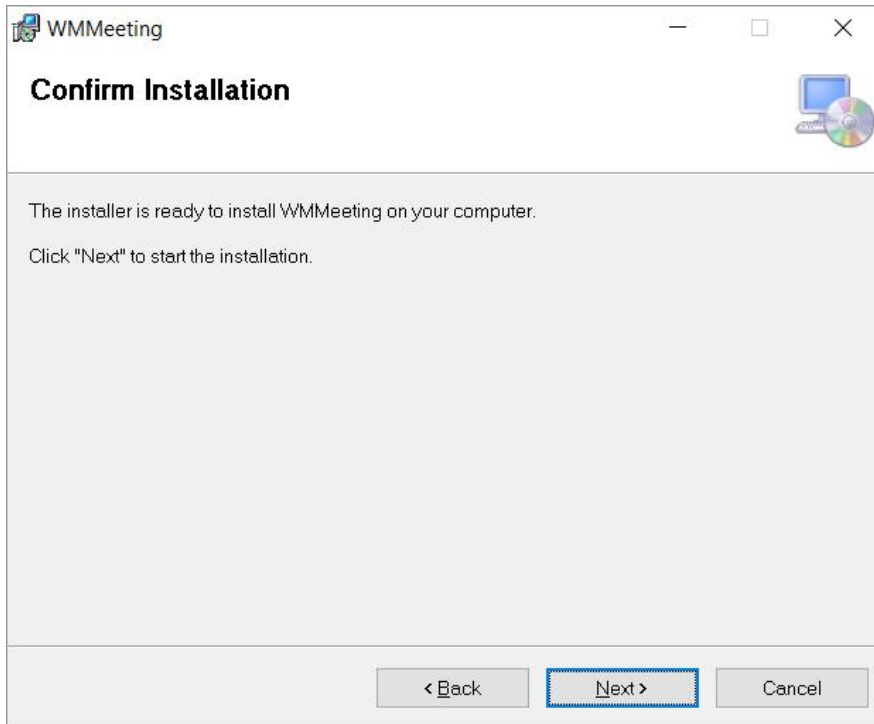

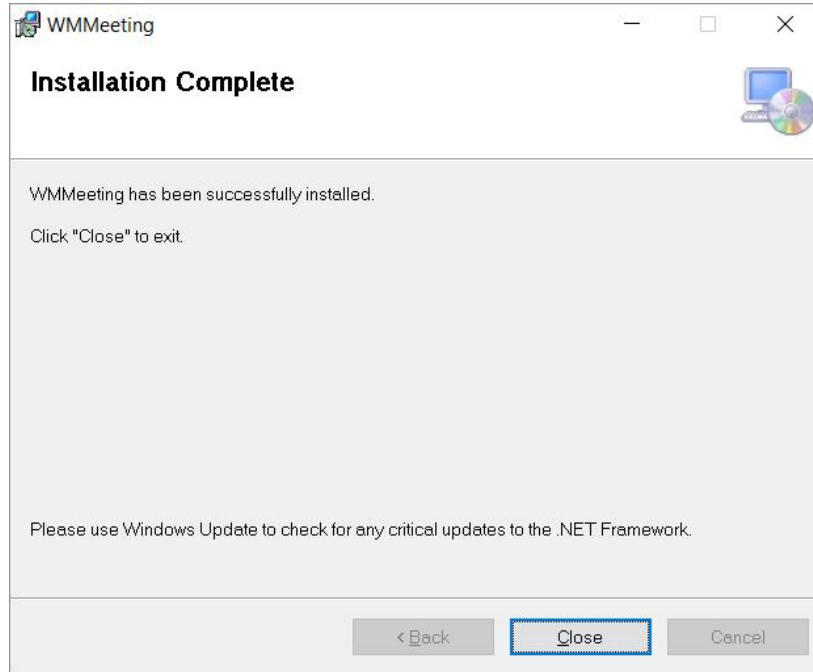

Now, the driver is installed.

DG-H18 (HDMI dongle)

1. Plug the USB port of DG-H18 to base unit to pair.
2. Plug the USB port and HDMI port of DG-H18 to PC/Laptop/MacBook. USB port for power and HDMI for AV.
3. Touch to mirror when the LED indicates is static green.
4. When LED is static red, the desktop is mirroring to the main screen.

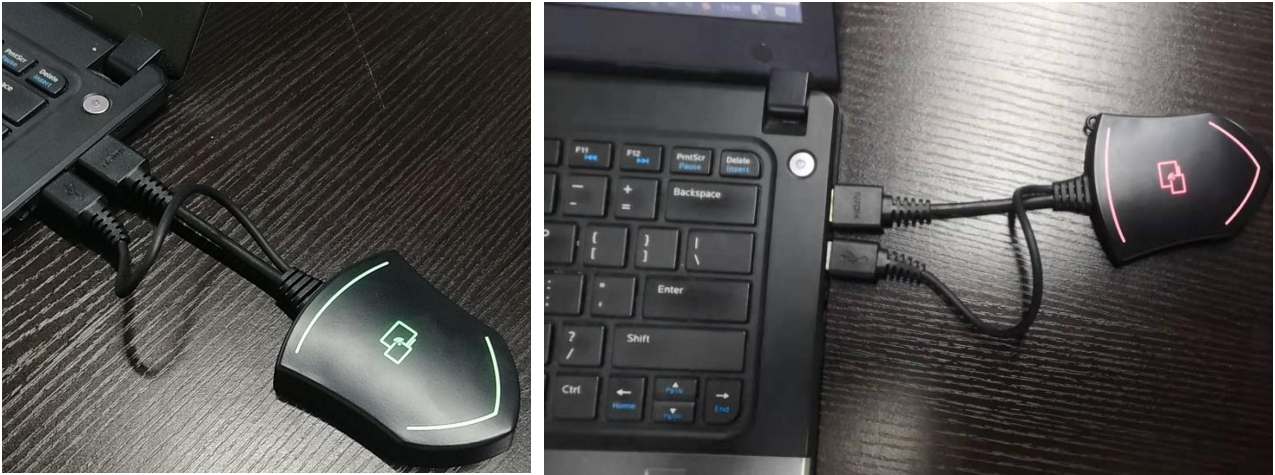

DG-C18 (Type C dongle):

1. Plug the Type C port of DG-C18 to base unit to pair.
2. Plug the Type C port of DG-C18 to PC/Laptop/MacBook.
3. Touch to mirror when the LED indicates is static green.
4. When LED is static red, the desktop is mirroring to the main screen.



5.3.2 Microsoft Windows PC/Laptop with application

For first time user, you have to **copy the Launcher program "WirelessMedia for Windows" first on your Laptop.**



1. Use a universal USB stick to create a “Launcher”, which is stored in the base unit. Connecting the USB stick to base unit and click the **DOWNLOAD** icon on the homepage to download “WirelessMedia–windows.exe” for windows PC/Lap–top, “WirelessMedia–macOS.app” for Macbook, “user manual” and “WMedia2.apk”.

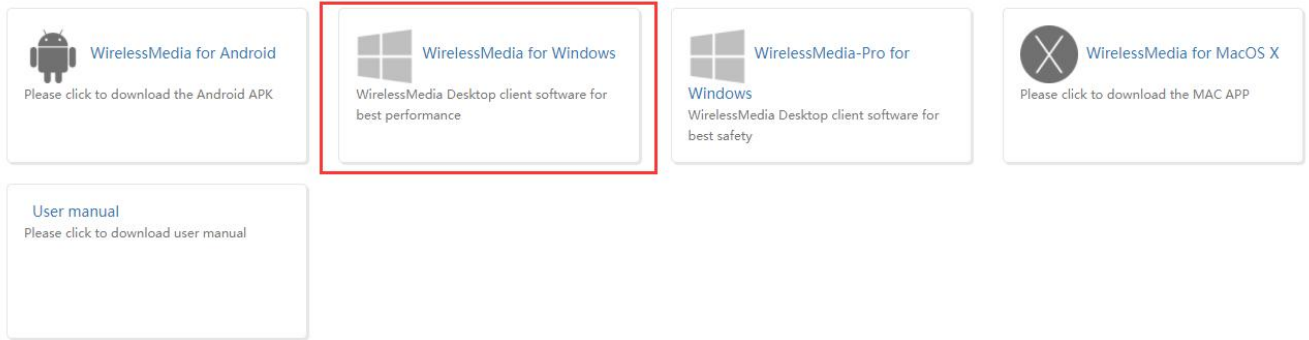

Or you could download the application from web page, by connecting PC with same network of base unit WU-10.



2. Connect your laptop to **Wi-Fi network displayed on the Home screen** (“Guest”, “Staff”), or connect to the **LAN** on the network using a network cable.

3. Double-click the "**WirelessMedia-windows.exe**" Launcher program  , a list of all available “WirelessMedia” in the **same network** will be displayed, select which device you want to connect to. The connections are password protected (lock icon ).



(LAN connection: several receivers possible)

(Wi-Fi: only 1 receiver)

4. Enter base unit password and click “connect”, the system is ready to share.

You can also manually connect by entering the name (SSID) or IP address. (click icon ).



Enter the corresponding base unit password, press 'OK', the system is “Ready to share”.

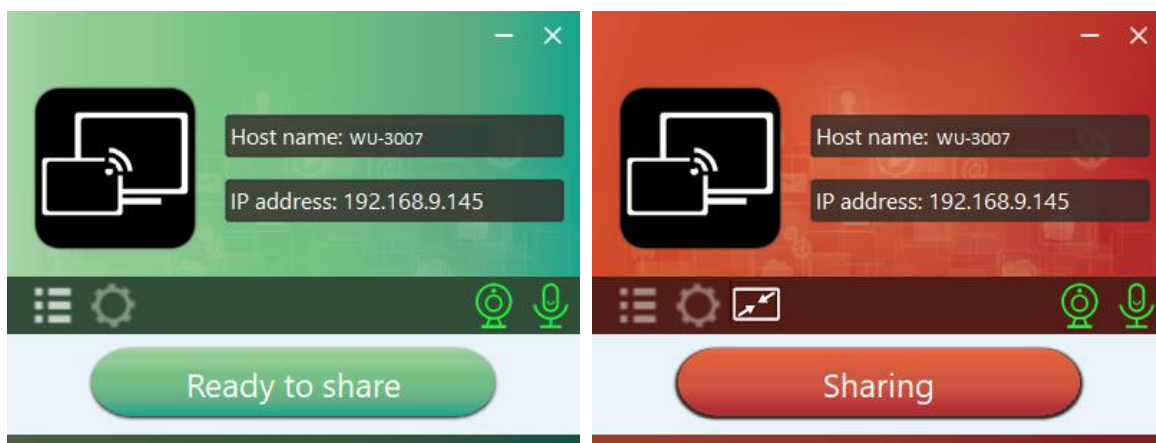

5. Click “Ready to share” in PC, when window color is static red, the desktop is mirroring to the main screen.



6. Click the **visual button again**, to stop mirroring, window color shows green again. You can minimize the

APP-window, in Windows taskbar you can see if screen is mirroring   or not .

Right click the WirelessMedia status icon  in Windows taskbar to open up the **context- menu**.

- **“About”**: You can check the software versions of the Base-unit, the dongle and the launcher program.

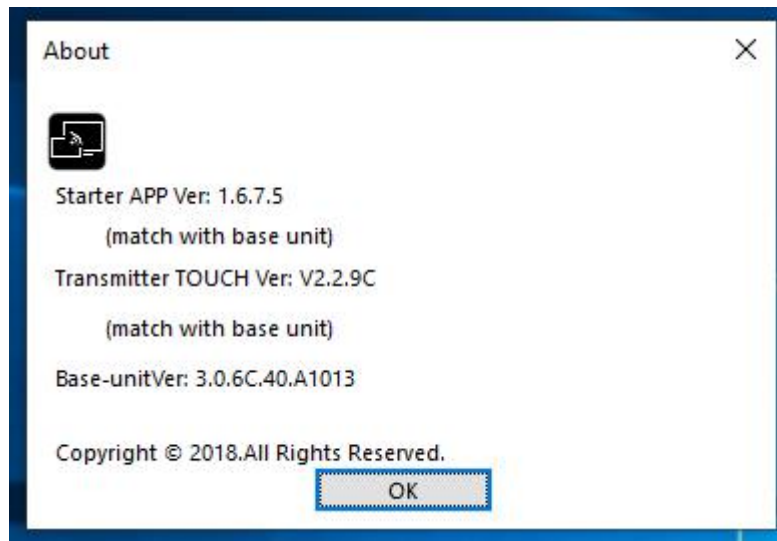

- **“Exit”**: End APP. Exiting the App completely.

If you click the **“close”** in the upper right corner of the app, the app in the task bar is only minimized and can be recalled again from the taskbar at any time.

5.3.3 Options for Microsoft Windows PC / Laptop – Extended Screen

Click the icon  in App to open/close “options”.

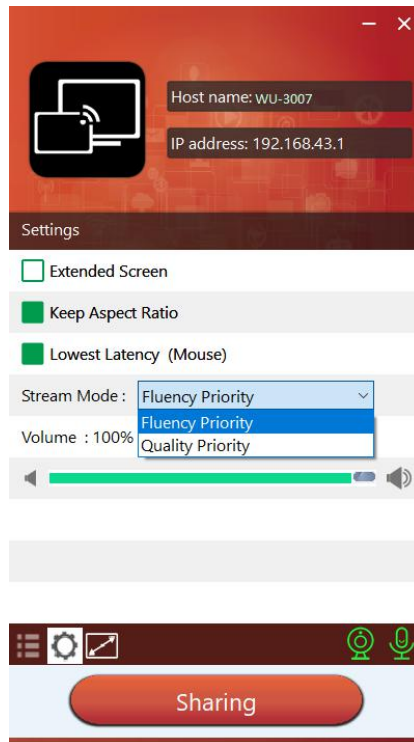

“Options”:

- **Extended Screen:**

Transfers extended desktop of active source. (depending on your operating system, may require the installation of the virtual driver “**ExtendedDisplay**” for function with Windows 10).

The primary screen (1) is displayed on the laptop and the virtually extended screen (2) is displayed on the main screen. If the PC has already connected an extended screen (3), the extended screen (2) will always be displayed on the main screen.

For the first time use of function “Extended Screen”, click the “Extended Screen”, will pop out a message to indicate the installation of the “ExtendedDisplay” driver. Click “yes” to continue, once installed, the “Extended screen” function is ready to use.

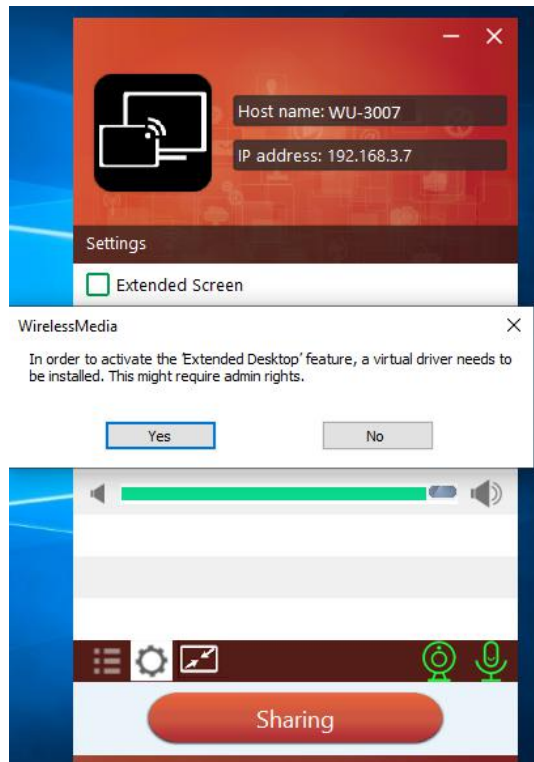

Note:

If you select the “Extended Screen” feature, Windows automatically switches to “Extended Mode”. If you stop the transfer with “WirelessMedia” (Pause), Windows remains in " Extended Mode" until you press "Windows key + P" on the laptop to select the "PC screen only" mode.

“Remote control” is available for “Extended screen” since Firmware version V3.0.7C.40A1020.

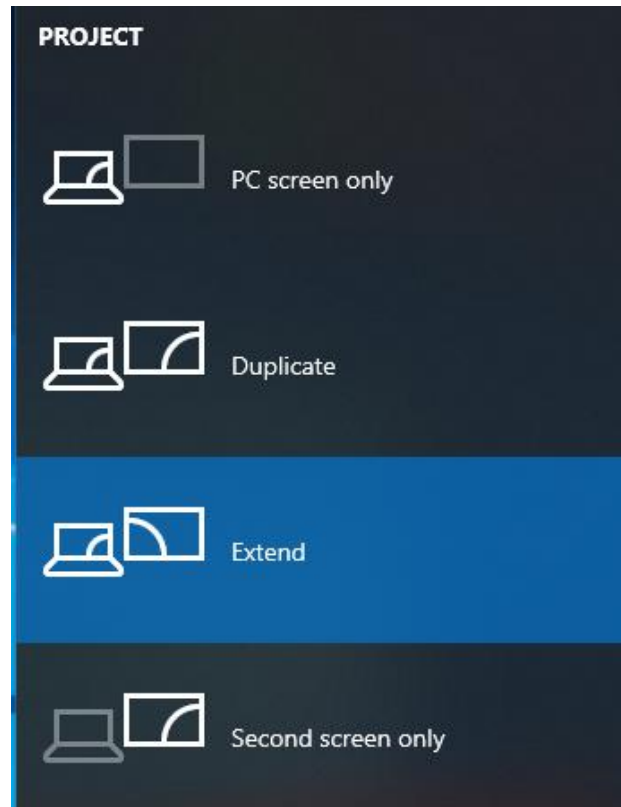

- **Keep Aspect Ratio:**

Keep the original aspect ratio to display on the main screen.

- **Stream Mode:**

- Fluency Priority: (Default) Image transmission delay is small, image resolution will be lower, suitable for PPT presentation mode.
- Quality Priority: The image resolution is relatively high, but when the image content is complex, the transmission delay will be relatively larger, suitable for watching video.

- **Low Latency Mouse:**

The setting is applied individually for this laptop only. The shape of mouse–pointer is equal the shape in application. There may be a small delay in movement of the cursor (approx. 150 ms). The movement of

mouse–pointer is displayed very smooth with **hardly noticeable delay** (about 20 ms) on the main screen, which significantly improves the operation of the application from the main screen. The look of the mouse pointer is every time, in all applications, like a typical cursor arrow.

- **Volume Slider:**

Adjust the playback volume of the main screen when presentation laptops is active.

5.3.4 MAC OS PC/Laptop with Dongle

At least **operation system macOS 10.9** is required.

DG–mini:

1. Plug DG–mini into USB/Type C port to pair with base unit. The “WirelessMedia–windows.exe” for windows PC/Lap–top, “WirelessMedia–macOS.app” for Macbook will be auto downloaded into DG–mini after paring mini dongle to WU–10.

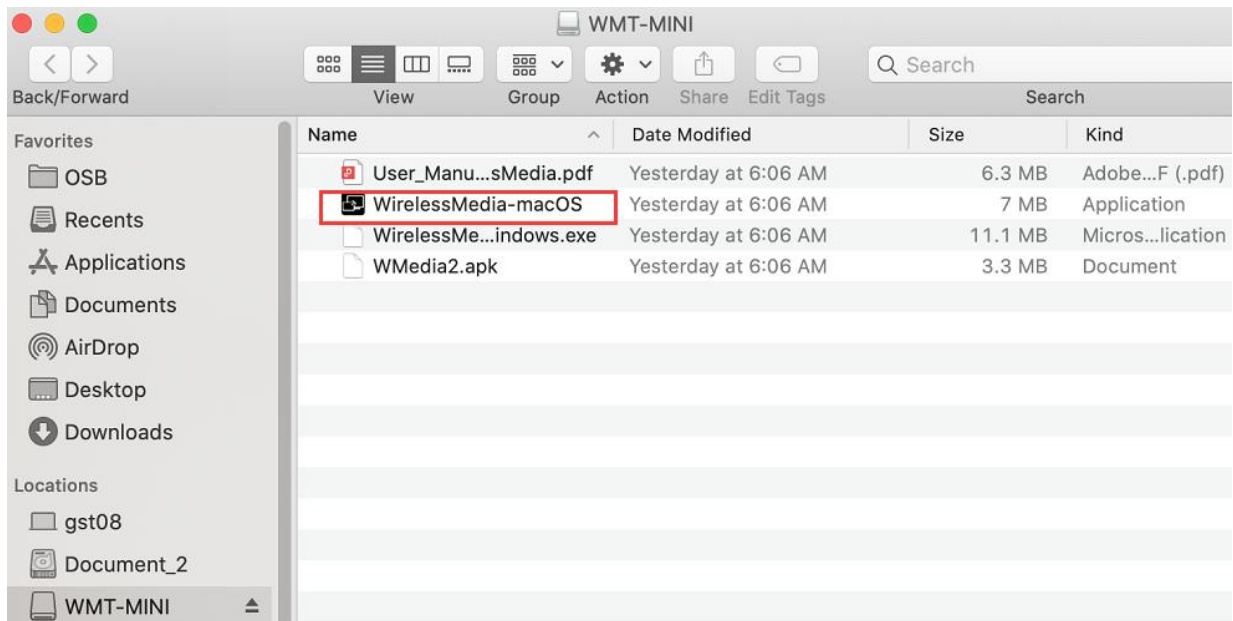

2. Plug DG-mini into PC/Laptop/MACbook and click the “Launcher” to run. DG-mini will auto change PC’s wifi to the target base unit wifi. No need to manually change PC’s wifi. It will pop out the message bar to enter the password to connect.

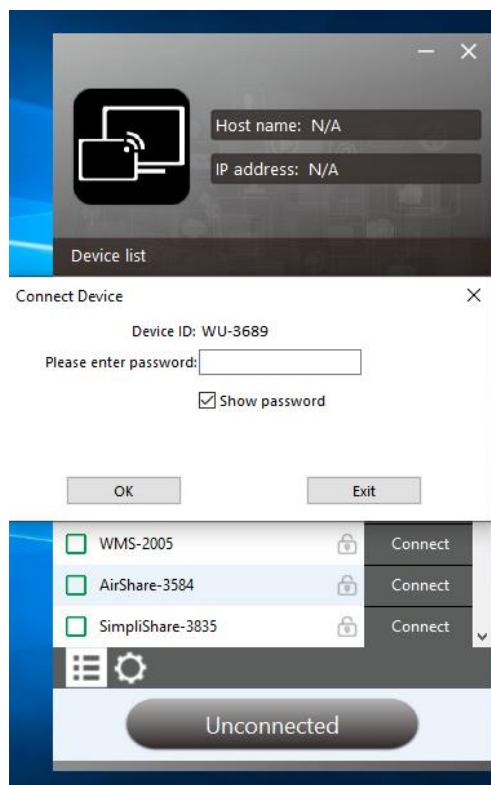

3. It will show “Ready to share”, click to share the desktop to screen.

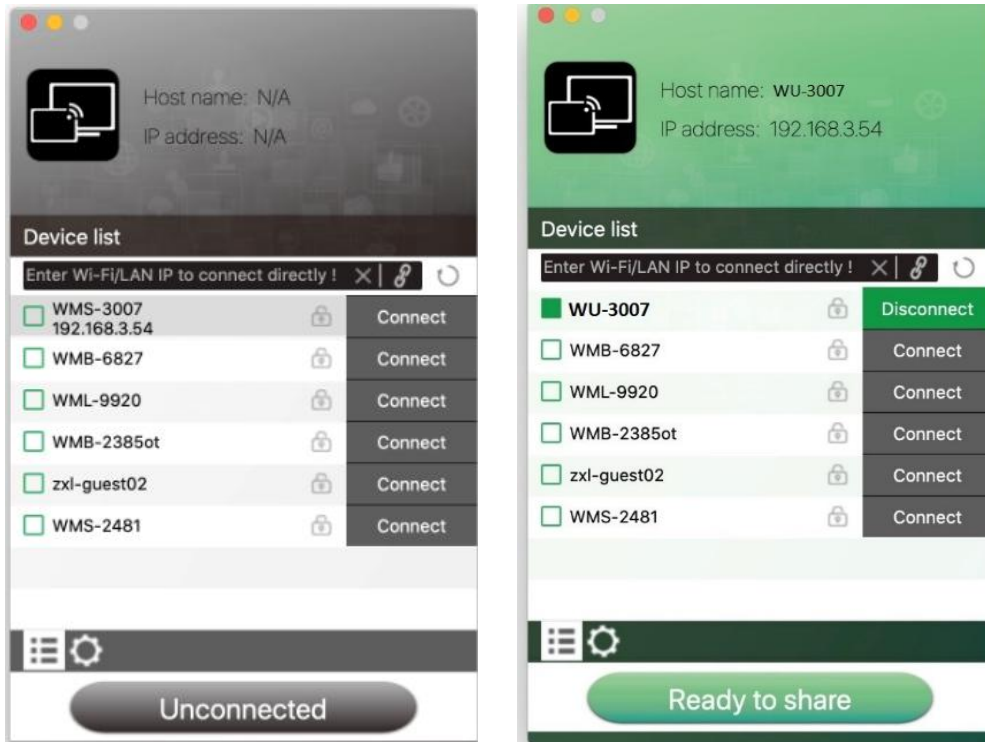

Note: for second time user, DG-mini will automatically run to share screen, no need to click “Launcher”.

DG-H18 (HDMI dongle)

1. Plug the USB port of DG-H18 to base unit to pair.
2. Plug the USB port and HDMI port of DG-H18 to PC/Laptop/MacBook. USB port for power and HDMI for AV.
3. Touch to mirror when the LED indicates is static green.
4. When LED is static red, the desktop is mirroring to the main screen.

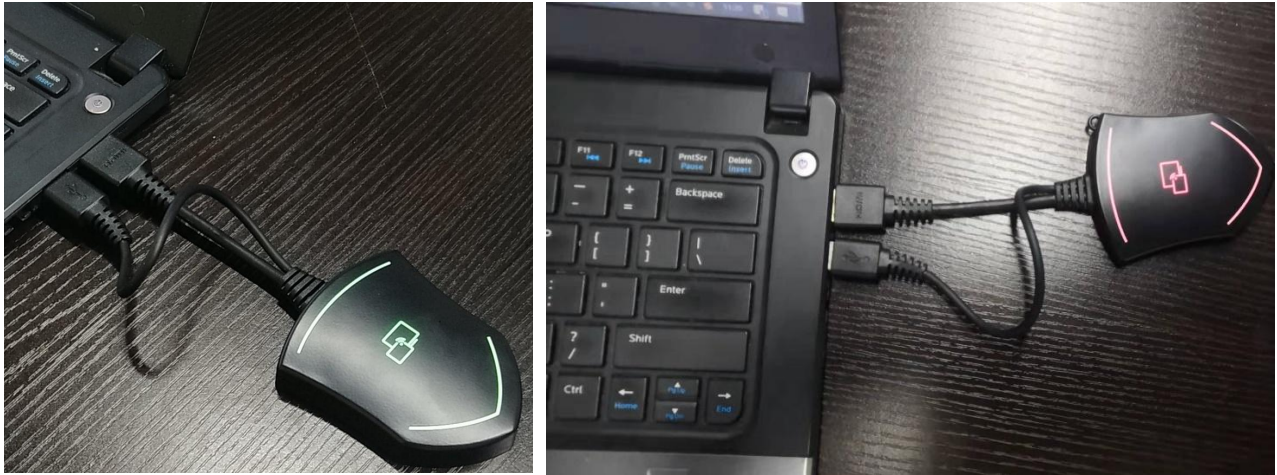

DG-C18 (Type C dongle):

1. Plug the Type C port of DG-C18 to base unit to pair.
2. Plug the Type C port of DG-C18 to PC/Laptop/MacBook.
3. Touch to mirror when the LED indicates is static green.
4. When LED is static red, the desktop is mirroring to the main screen.



5.3.5 MAC OS PC/Laptop with application

For first time user, you have to **copy the Launcher program "WirelessMedia for Mac" first on your Mac.**

1. Use a universal USB stick to create a "Launcher", which is stored in the base unit. Connecting the USB

stick to base unit and click the **DOWNLOAD** icon on the homepage to download

“WirelessMedia–windows.exe” for windows PC/Lap–top, “WirelessMedia–macOS.app” for Macbook, “user manual” and “WMedia2.apk”.



Or you could download the application from web page, by connecting Macbook with same network of base unit WU–10.

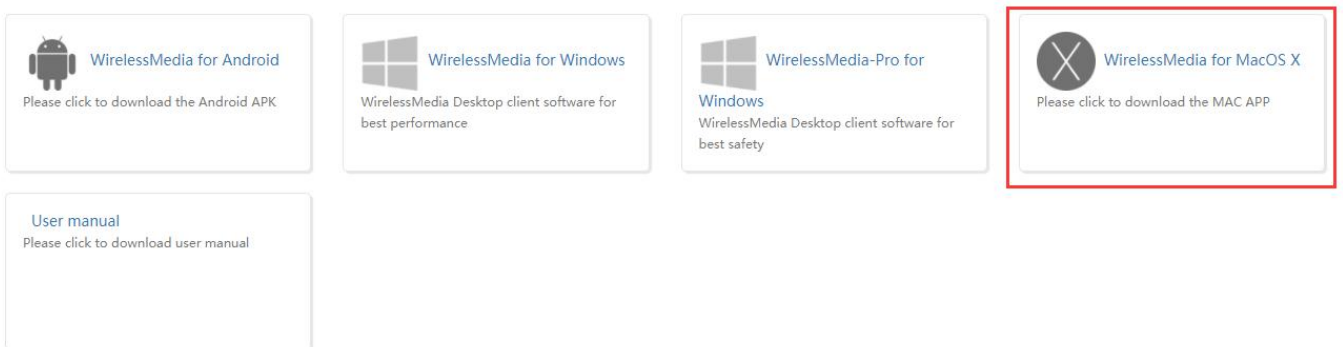

2. Connect your Mac to **Wi-Fi network displayed on the Home screen** (“Guest”, “Staff”), or connect to the **LAN** on the network using a network cable.
3. Double–click the **“WirelessMedia for Mac”** Launcher program  , a list of all available

“WirelessMedia” in the **same network** will be displayed, select which device you want to connect to. The

connections are password protected (lock icon ).

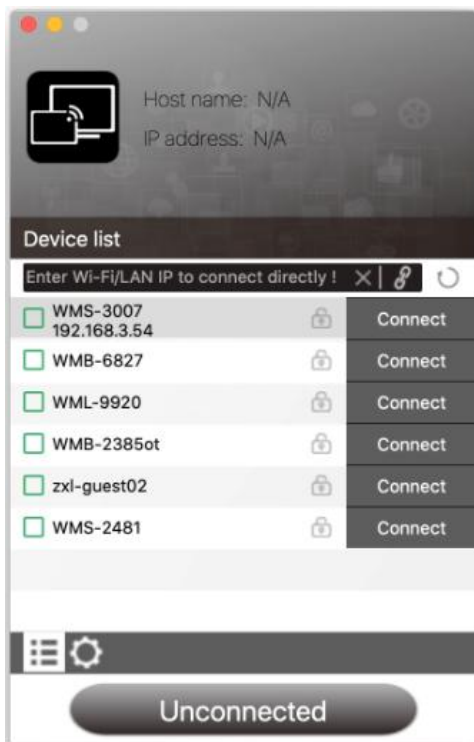

(LAN connection: several receivers possible)

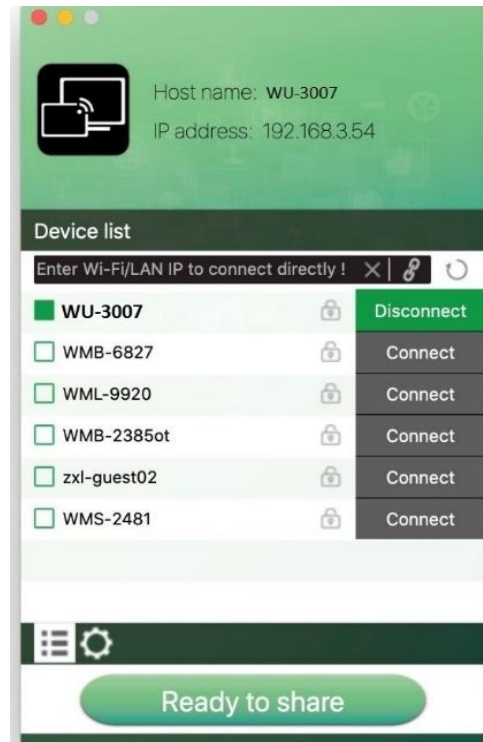

(Wi-Fi: only 1 receiver)



4. Enter base unit password and click “connect”, the system is “Ready to share”.

You can also manually connect by entering the name (SSID) or IP address. (click icon ).

Enter the corresponding base unit password, press 'OK', the system is “Ready to share”.

5. Click the visual button “Ready to share” in Mac, when window color is static red, the desktop is mirroring to the main screen.



6. Click the **visual button again**, to stop mirroring, window color shows green again. You can minimize the APP-window, in top menu-bar you can see if screen is mirroring   or not .

Right click the WirelessMedia status icon  in top menu-bar to open up the **context- menu**.

- **“About”**: You can check the software versions of the Base-unit, the dongle and the launcher program.



- **“Exit”**: End APP. Exiting the App completely.

If you click the **“close”** in the menu bar of the app, the app in the top menu-bar is only minimized and can be recalled again from the top menu-bar at any time.

5.3.6 Operations for Apple MacOS, MacBook – Extended Screen

Click the icon  in App to open/close “options”.

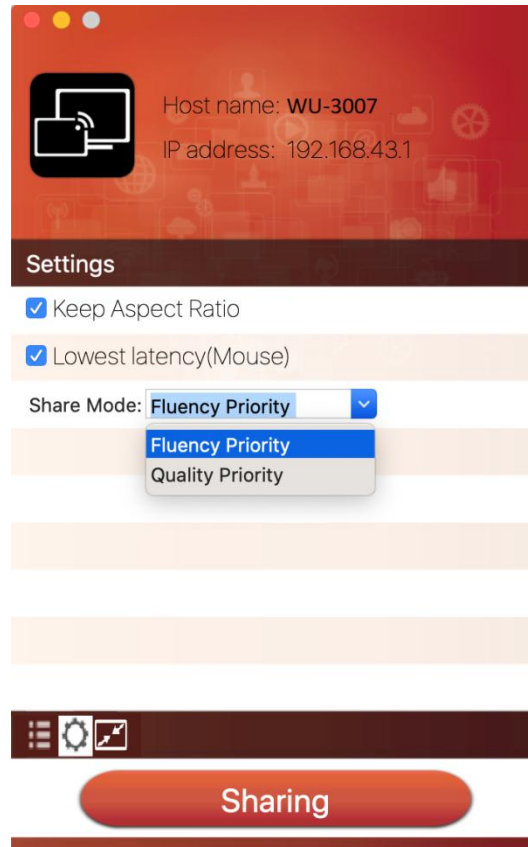

“Options”:

- **Extended Screen:**

Transmits the Extended desktop (“Use a Separate Display”) **only via AirPlay**, when activated for Display on WirelessMedia.

- **Keep Aspect Ratio:**

Keep the original aspect ratio to display on the main screen.

- **Lowest Latency (Mouse):**

The setting is applied individually for this laptop only. The shape of mouse–pointer is equal the shape in application. There may be a small delay in movement of the cursor (approx. 150 ms). The movement of

mouse–pointer is displayed very smooth with **hardly noticeable delay** (about 20 ms) on the main screen, which significantly improves the operation of the application from the main screen. The look of the mouse pointer is every time, in all applications, like a typical cursor arrow.

- **Stream Mode:**

- Fluency Priority: (Default) Image transmission delay is small, image resolution will be lower, suitable for PPT presentation mode.
- Quality Priority: The image resolution is relatively high, but when the image content is complex, the transmission delay will be relatively larger, suitable for watching video.

5.3.7 Quad view mirroring

WU-10 base unit can mirror 4 sources onto main display simultaneously, which supports PC/Laptop and mobile devices.

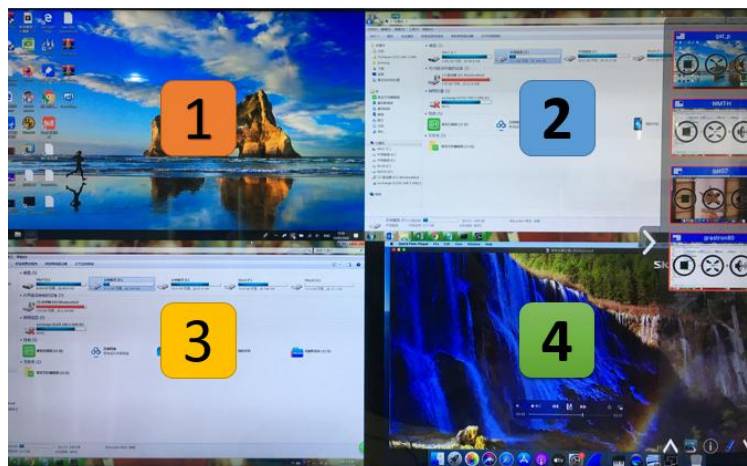

Note: By clicking full screen icon  on PC UI interface, or long press the dongle, the content will be full displayed on screen. Click or short press again, the screen back to quad view mode.



5.3.8 Mobiles Devices

Sharing on Android devices

1. Open the “WirelessMedia” application.

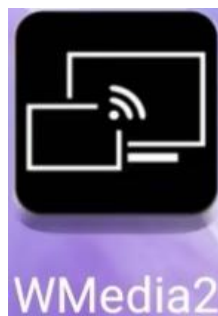

2. Connect your mobile device to one of the displayed Wi-Fi networks.
3. Open the “WirelessMedia2” application in your mobile device, and you will see the Home Page of

“WirelessMedia2” as shown below. and click the device list refresh button  for

Android, which is highlighted in red circles as shown below:



4. Select the base unit you want to connect, enter password and mirror.



5. After completing the pairing, it shows OSD “Welcome ***” on the home page. For example, if we connect

it by a HUAWEI-PAR-AL00, it shows a “HUAWEI-PAR-AL00” on screen, as shown below.



- 6. Now you can mirror your desktop of your mobile.
- 7. Click again the button “Share Screen” to stop mirroring.

✧ Click the connected device name to check the base unit status and base unit firmware version.

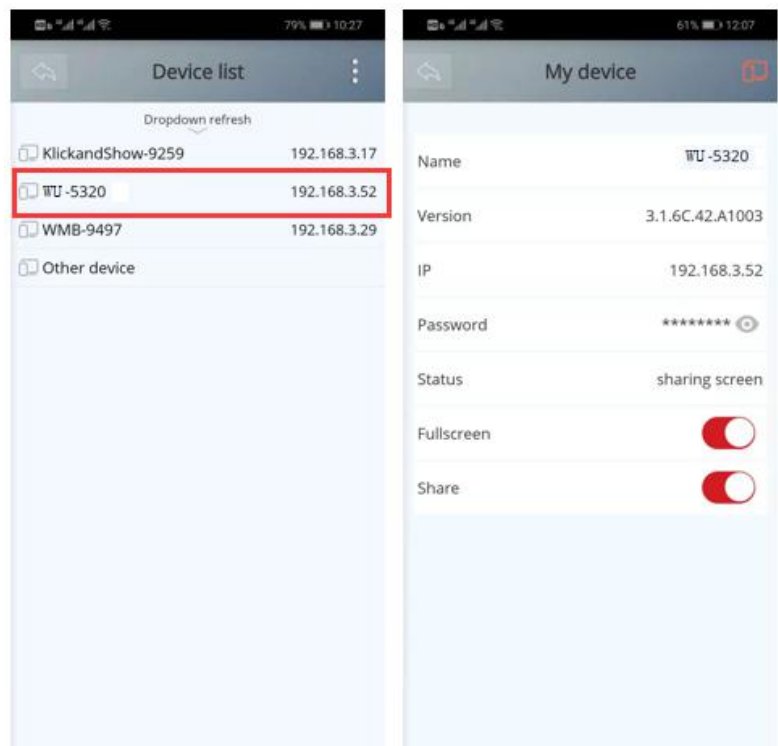

✧ Click “Fullscreen” to be full screen in the main screen when more than one signal is connected and shared.



✧ Click the upper right corner icon, check the “WirelessMedia2” application version information.

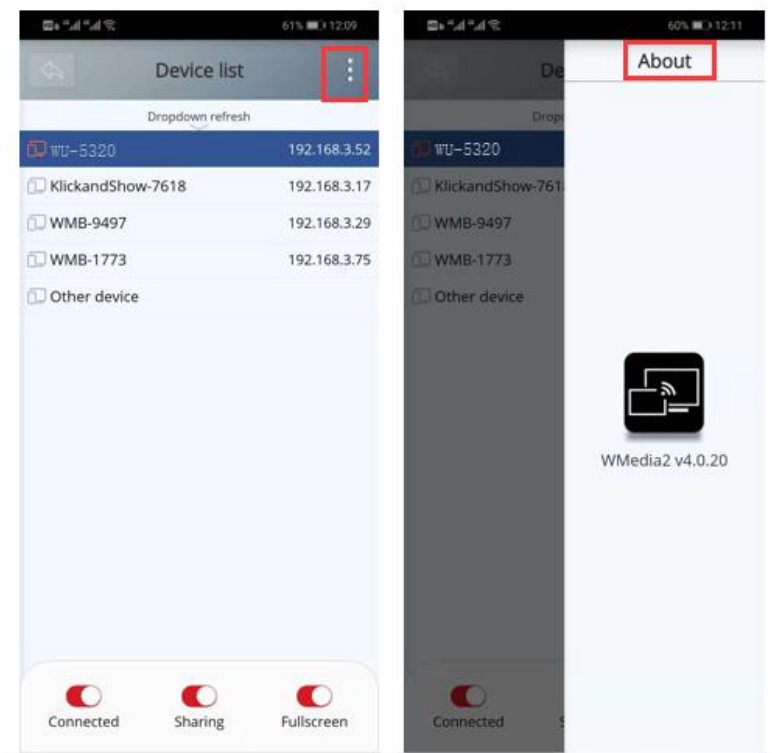

Sharing on IOS devices

1. With **AirPlay** technology, user can stream his screen or music, (YouTube-) videos, pictures ... wireless to

Base-unit. Connect your iOS device with the same Wi-Fi network from WU-10.

For IOS devices, activate the control center. Click the **Airplay** icon  on your Apple device and select the target WU-10 to start mirroring through the WU-10 to the main screen.

It will show OSD on home screen after connecting successfully.



5.3.9 Miracast on Android Devices and WIN10 PC/Laptop

Android Devices

Steps as below:

1. Make sure the Wi-Fi or WLAN is enabled.
2. Swipe down from the top of phone's screen and click the wireless projection icon in the popup page.

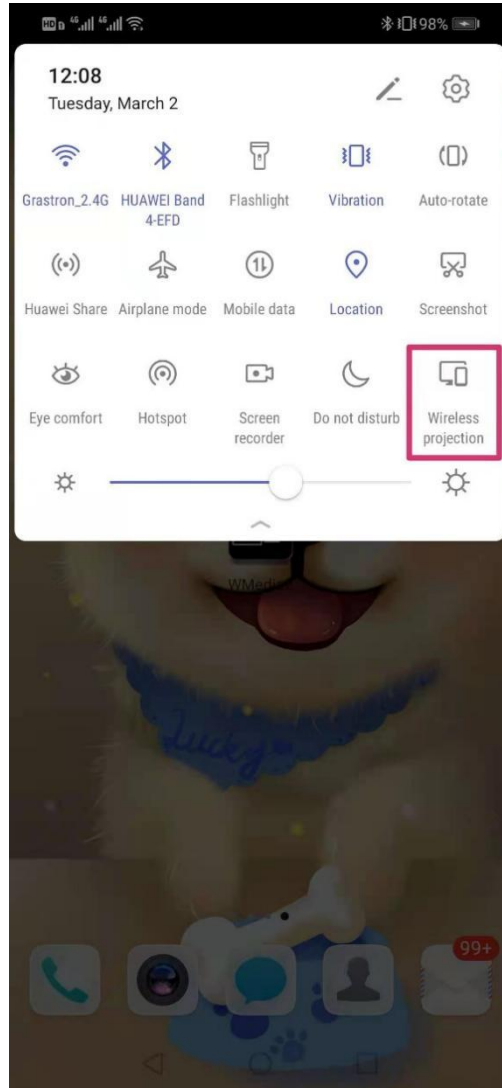

3. It will pop out the wireless projection window, find the proper base unit WMB-5320 in the available list to connect.

Note: under Security Level 1 mode, there is no need to enter password to connect. Under Security level 2 and Security level 3 mode, it will need to enter password on WU-10 home screen to connect and mirror.

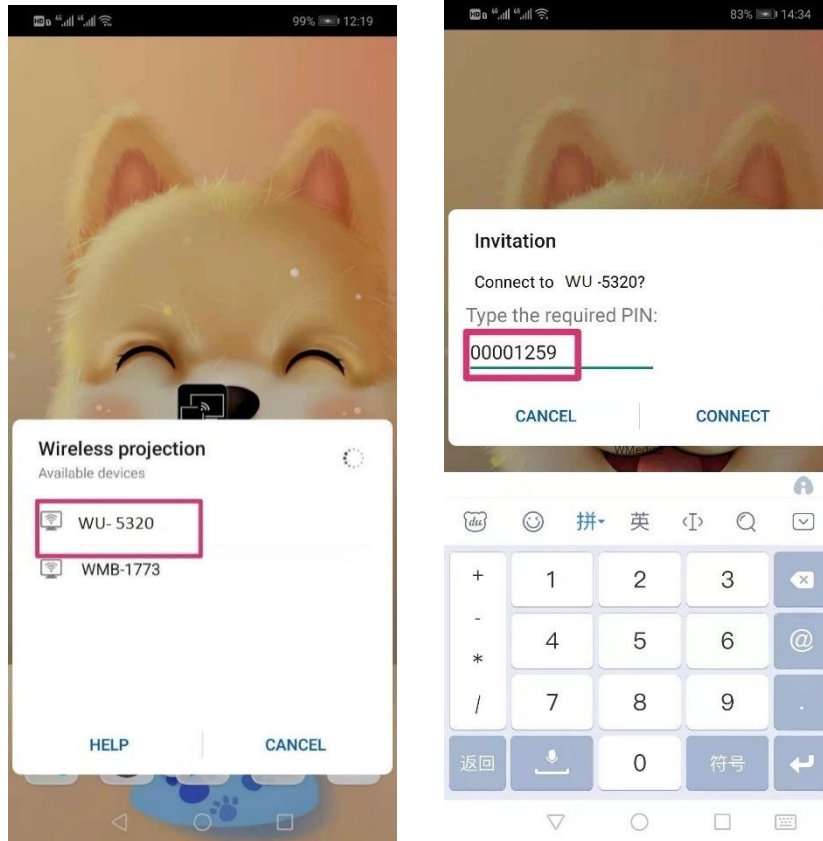

4. After entering password, it will show your mobile content on display.
5. Click the “wireless projection” icon again, disconnect to stop mirroring.

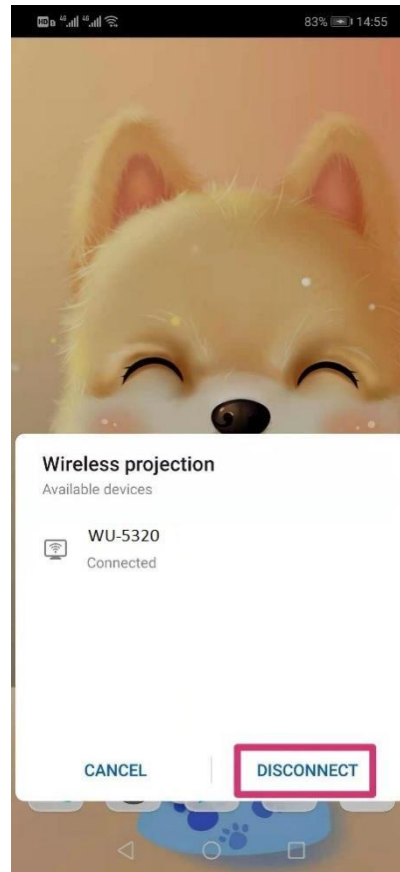
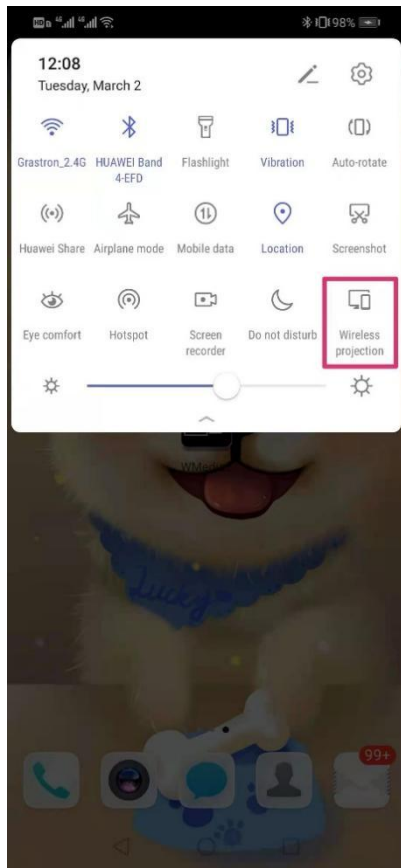

WIN10 PC Miracast

1. Make sure the Wi-Fi or WLAN is enabled.
2. Click the PC bottom right corner operation zone icon as below.

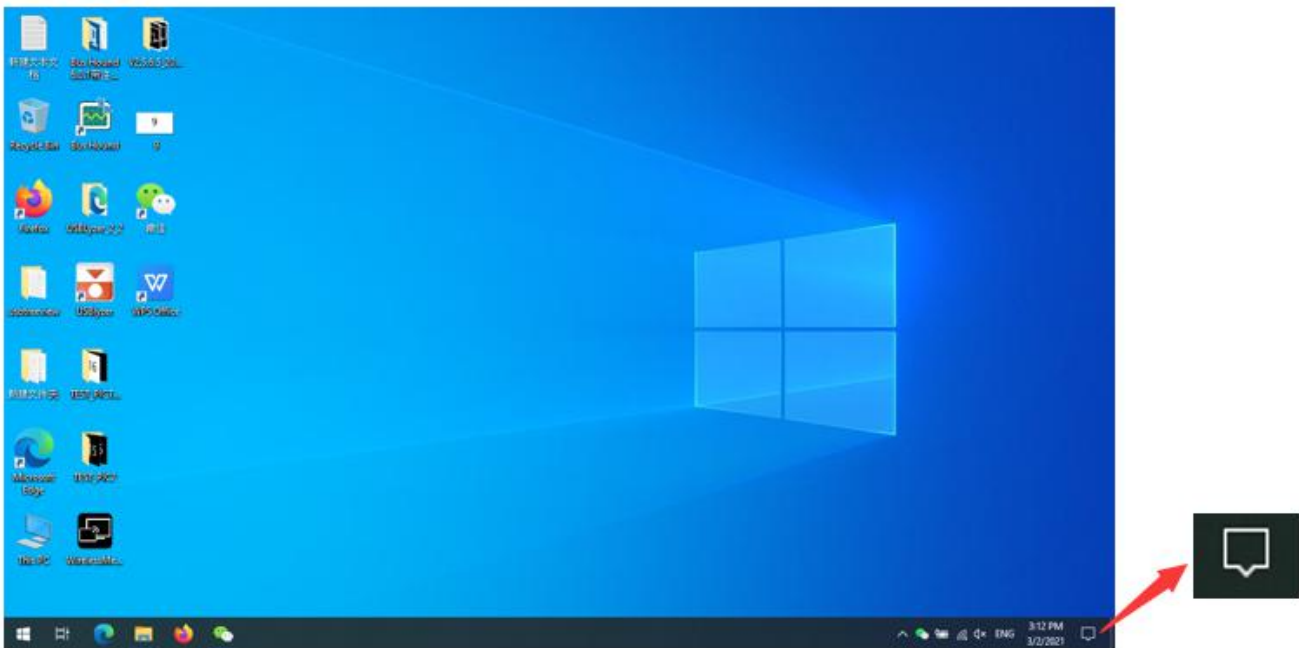

3. Click “project” icon to enter password on home screen to connect and mirror.

Note: under Security Level 1 mode, there is no need to enter password to connect. Under Security level 2 and Security level 3 mode, it will need to enter password on WU-10 home screen to connect and mirror.

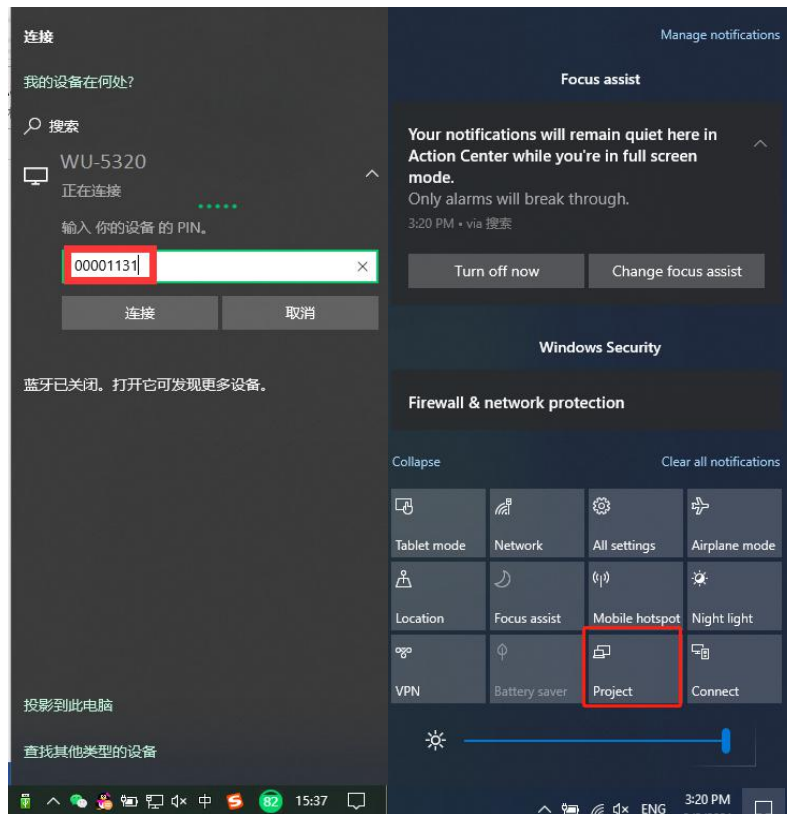

4. After entering password, it will show your mobile content on display.

5. Click the “project” icon again, disconnect to stop mirroring.

5.3.10 Chromecast on PC

WU-10 support Chromecast function on WIN 7 and WIN 10 PC.

PC and WU-10 base unit need to be in the same LAN network to start cast content onto screen via Chromecast.

1. Open Chromecast browser, connect your PC with same network of WU-10 as below pic.

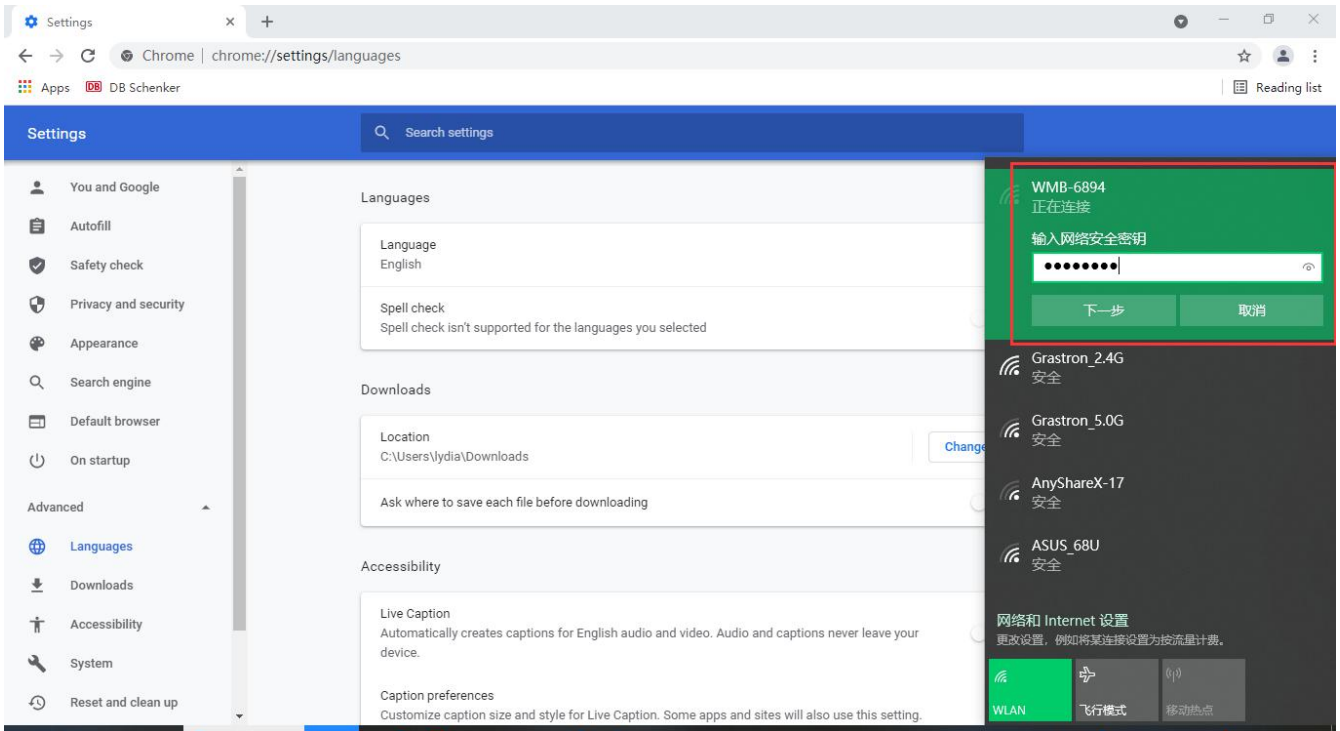

2. Click “cast” to start Chromecast function.

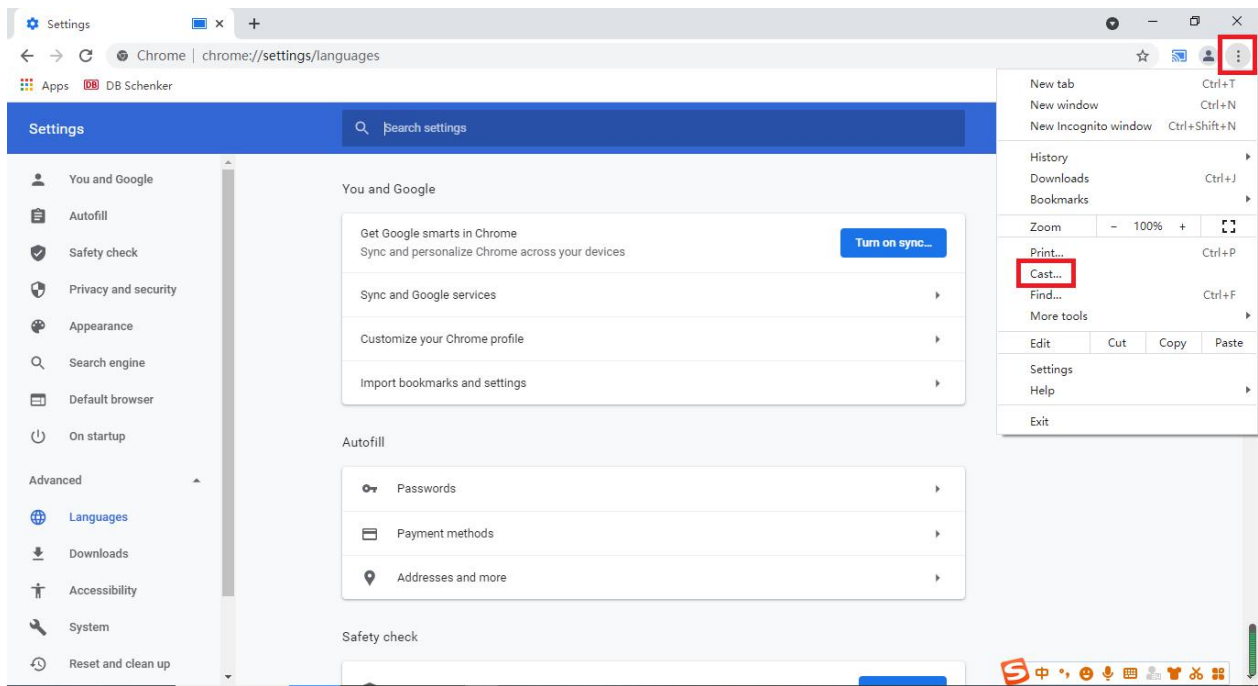

3. Find target base unit SSID as below. Click to connect.

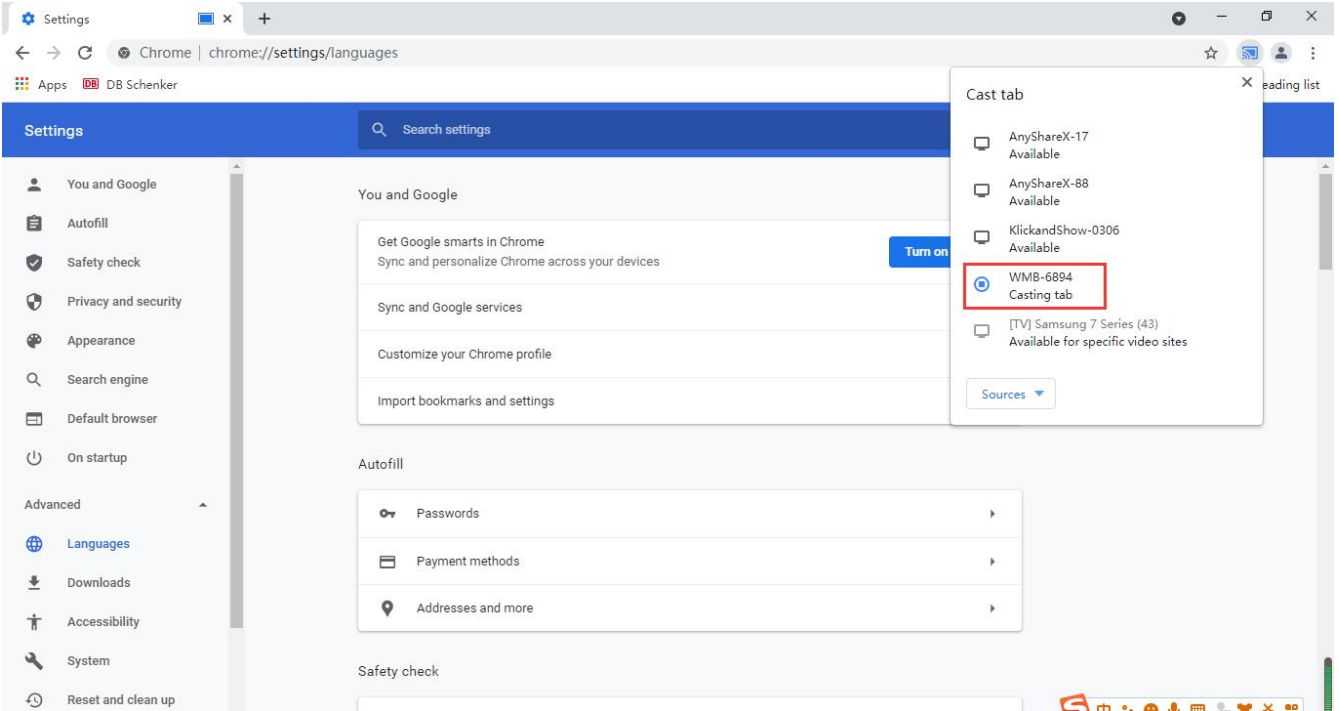

4. Three options to choose to cast.



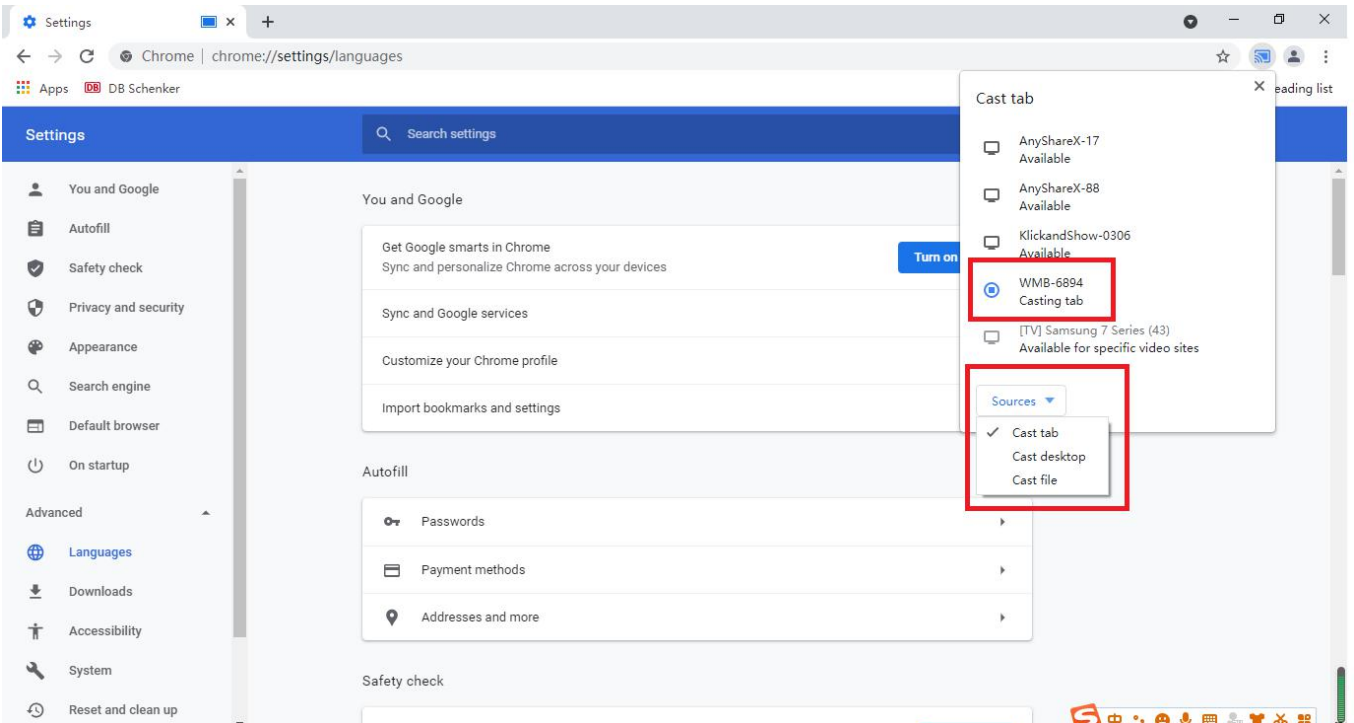

Cast tab, Cast desktop, Cast file.

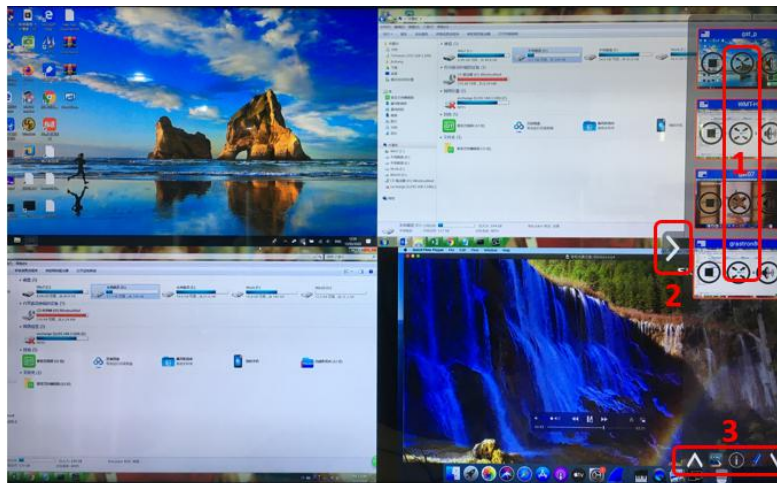

5.4 Preview Window

At touch-screen or with mouse of Base-unit, you can click on LEFT or RIGHT-arrow (2), to show the small preview-windows as a bar on the right edge of the screen, or to hide them, if they are disturbing. Once the preview windows are activated, you see live-pictures (1) of all connected transmitters and android devices via “WirelessMedia2” APK at the right edge of the screen. Just scroll UP or DOWN (3) to see further preview pictures.



As soon as presenter is clicking with mouse of Base-unit, or clicking with finger at touch-screen, the appropriate participants of the meeting is activated, another click at the arrow shows his picture at the main screen in full format. A red frame is shown for the active picture. The button  indicates play button, click to show screen. The button  indicates step out screen, click to stop mirroring the current signal. The button  indicates full screen, click to be full on main screen. The button  indicates volume, click to adjust the volume of connected signal.

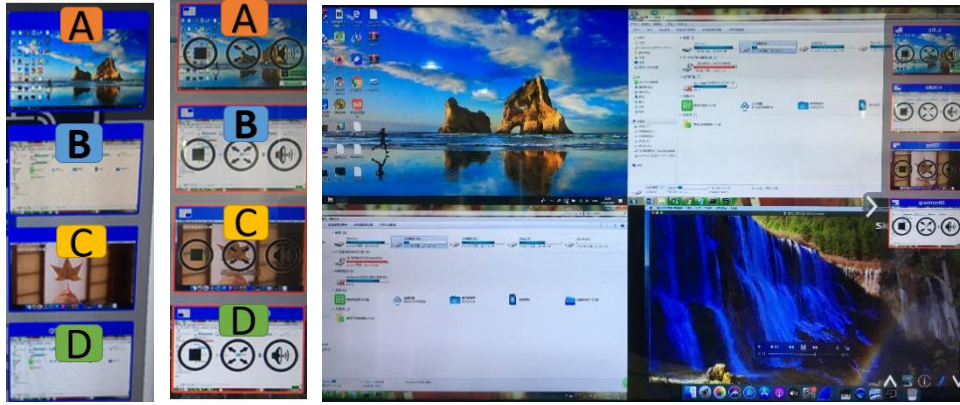

5.5 Whiteboard & Annotation

Whiteboard and **Annotation** requires an HID compatible device, such as interactive white board or interactive touch screen. It is easy to use, makes collaboration in your business more productive and effective: documents can be easily written, edited, captured and shared.



Whiteboard: write all your ideas and share the digital notes with anybody. Different colors of pen and background can be selected.

Annotation: draw or write annotations in overlay within your documents, presentations. Save and share everything that was discussed. Different colors of pen can be selected.

How to start Whiteboard or Annotation mode

The “Preview window” in Home Screen to start this mode.

Tap (click) the LEFT-arrow (1), located on the right side of the screen, and select

Whiteboard  or Annotation icon  icon in (2).



Icon in (2) indicates “information”, click to check the base unit SSID, password, Wifi IP and Lan IP address when some device are sharing on main screen. This info will show on main screen at least 20s then will disappear automatically. In order to let other attendees join into meetings as well.

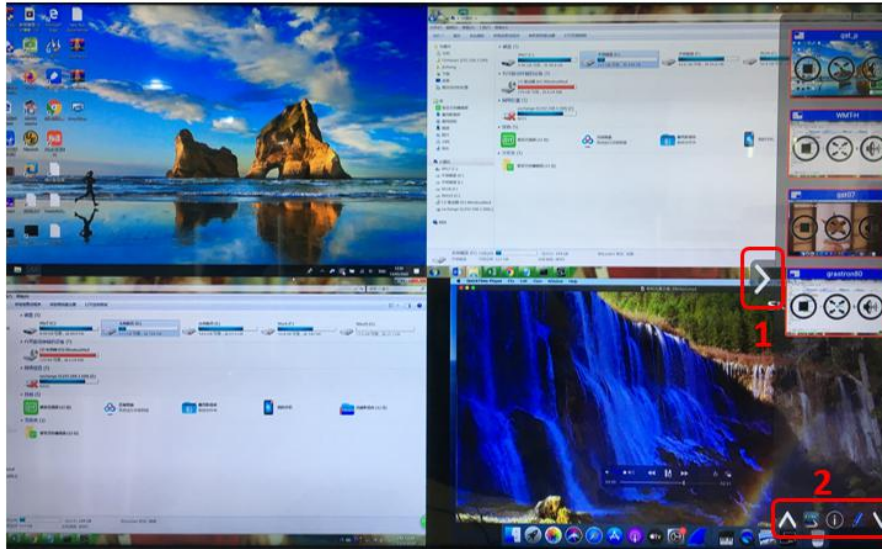

The toolbar for Whiteboard or Annotation appears in the bottom of your screen.

If another user is mirroring, the Whiteboard & Annotation function is closed.

5.5.1 Whiteboard



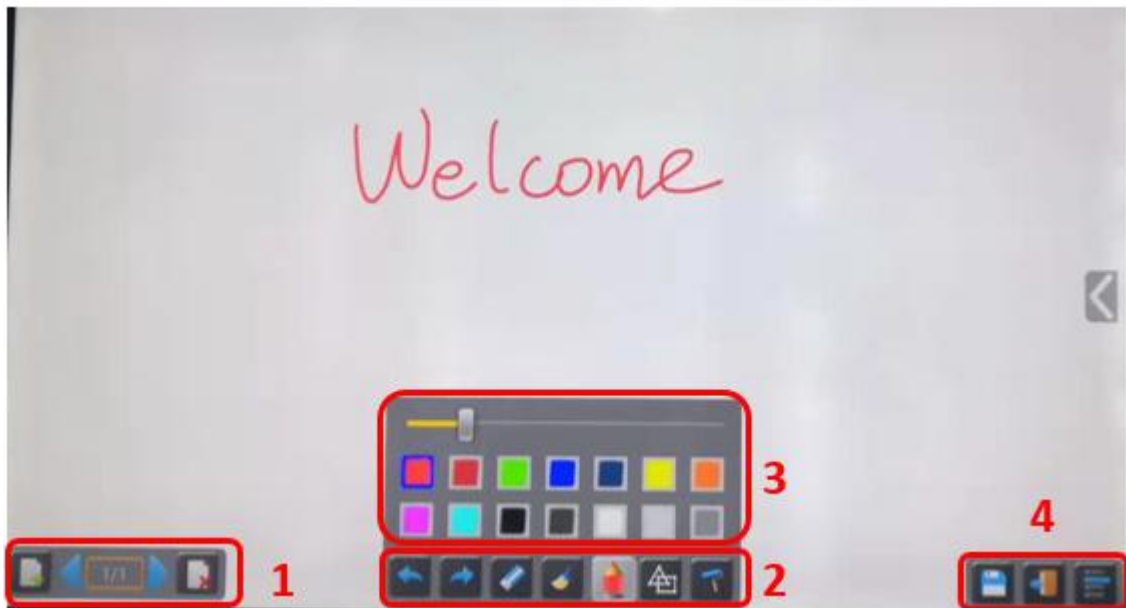

Click on the icon to enter the white Whiteboard page. You can create free drawings with your finger at

touch screen, mouse (multitouch capability).



Use the toolbar to select one of the following functions.

ID	Icons	Function
Tool bar 1		<p>Add an empty page</p> <p>Delete the actual page</p> <p>Display previous or next page</p>
Tool bar 2		<p>Undo: one step backward in changes</p>



Redo: one step forward in changes

Erase part of drawings or annotation, change diameter by a longer tap

Clear the entire drawing/writing on the screen

Pen allows writing/drawing in different colors

Draw basic geometric shapes

Select color of board, the drawing will be kept

Tool bar 3

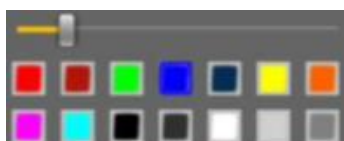



will pop up, when “Pen” or “Draw shape” or “Select color of board” is selected, for individual change of size of Pen, Shape or color.



Use the toolbar to select one of the following functions.

ID	Icons	Function
Tool bar 1		<p>Undo: one step backward in changes</p> <p>Redo: one step forward in changes</p> <p>Erase part of drawings or annotation, change diameter by a longer tap</p> <p>Clear the entire drawing/writing on the screen</p>

		<p>Pen allows writing/drawing in different colors</p> <p>Draw basic geometric shapes</p>
<p>Tool bar 1</p>	 	<p>Close Whiteboard to go back to Home screen, actual project can be saved on local storage (WMN)</p> <p>Close Whiteboard to go back to Home screen,</p> <p>Save the current screenshot on local storage (PNG)</p>

Download the drawings to connected users

Scan the QR-code with your mobile's camera or enter the given IP-address in a browser. If the network connection is set properly, you will get the saved files on Base unit, which you can download as PNG file. The possibility for download will be closed after you click OK. You can copy data to USB disk and put this USB disk into the Base-unit and import with "Import from U disk" to the Whiteboard-section.

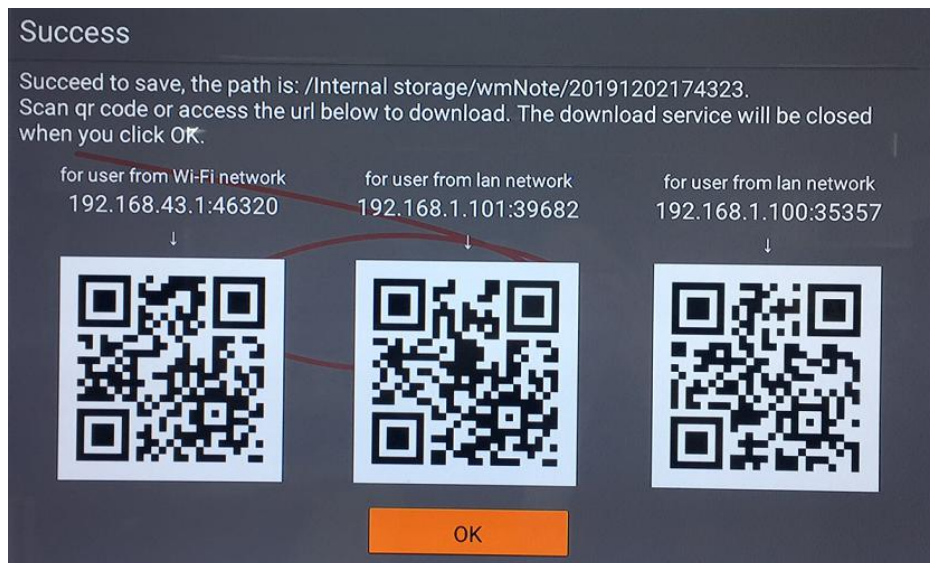

http://192.168.43.1:38238/



Files on base unit:/111

name	size	modify date	action
0.png	381.5 KB	19-12-02 PM04:57	download

6. Strat video conferencing via USB-over-WiFi technology

To start the soft video conference easily with your own laptop, but utilize the room USB devices like camera, microphone and speaker to have a better AV experience.

6.1 Start with DG-mini dongle or PC application

1. Make sure the room USB devices and display are well connected with WU-10 by cables.

2. Refer to **chapter 5.3.1** and **chapter 5.3.2**, make sure the laptop is well connected with WU-10 base wirelessly, either by software application or dongle transmitter DG-mini.
3. Virtual driver is required to install in windows OS to support USB over Wifi for the 1st time, MAC OS to support USB over Wifi is still under development, when the driver is well installed, there will be two icons of camera and mic shown in the application UI, the white color indicates the USB camera and speaker/mic are connected, the green color indicates the USB camera and speaker/mic are in use for example by VC applications.

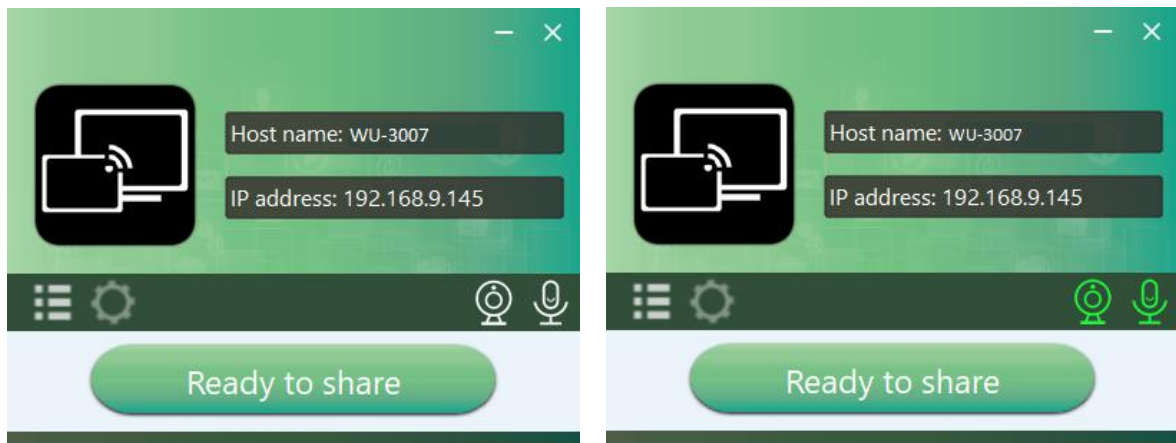

4. Launch VC application such as Zoom from desktop, choose **Settings>Video>Camera>Virtual Meeting**

Camera

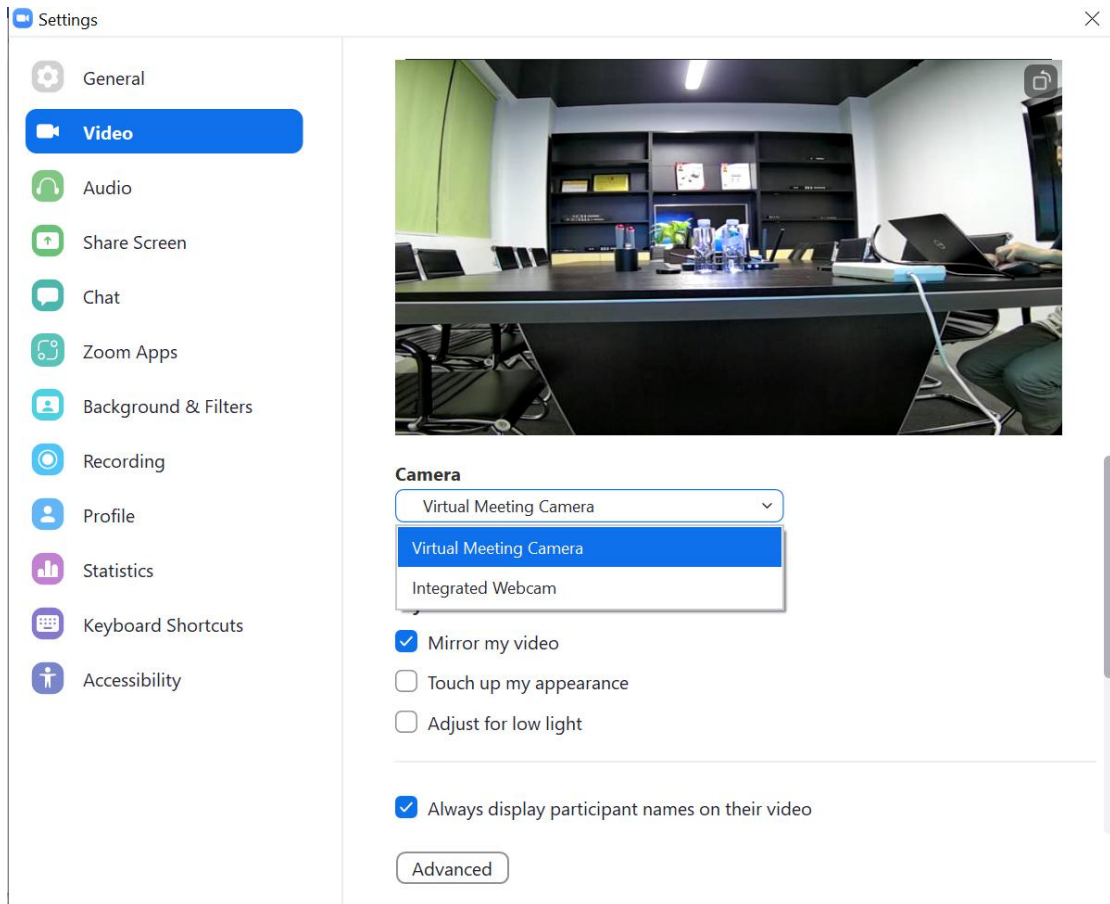

Settings>Audio

For Speaker, select Virtual Meeting Audio

For Microphone, select Virtual Meeting Audio, too

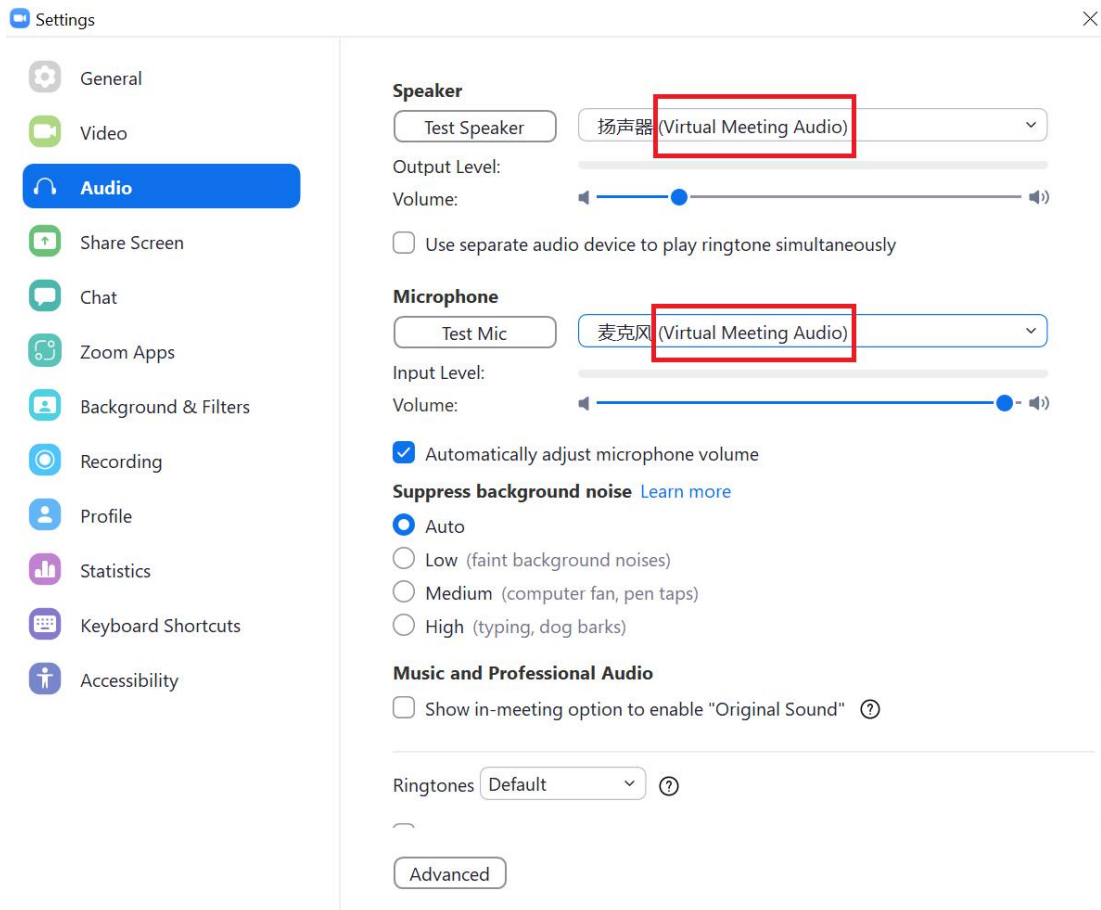

5. Click “Ready to share” button in the application, sharing the desktop of laptop to the display

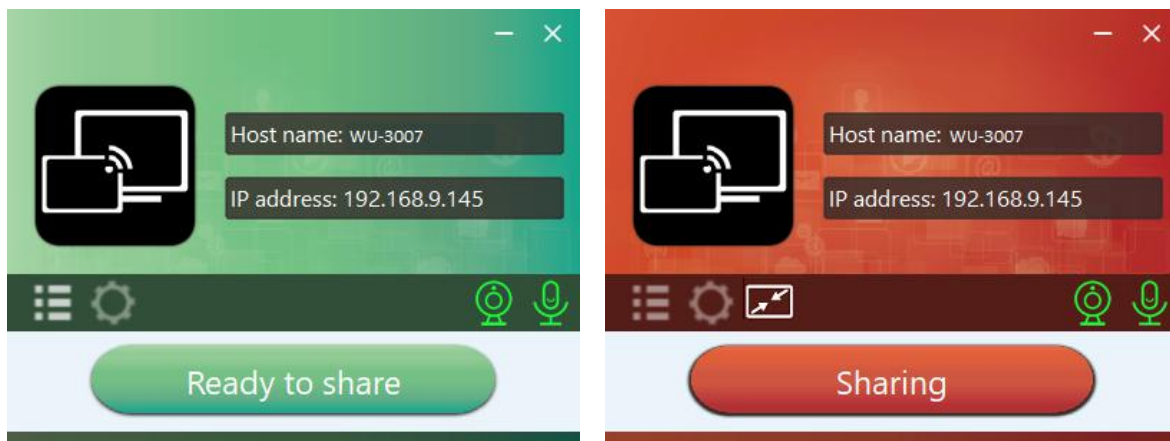

Now, you are ready to start video conferencing on Zoom with room USB devices and display.

6.2 Start with HDMI dongle or Type C dongle

Note: when starting a wireless conference via dongle, for first time use, it will need to double click the “WirelessMedia.exe” application to run, which is in your CD Drive of PC as

below path. Since second time use, the software will be run in the background of Windows OS automatically, this is a patent avoiding operation, end user can ignore it.

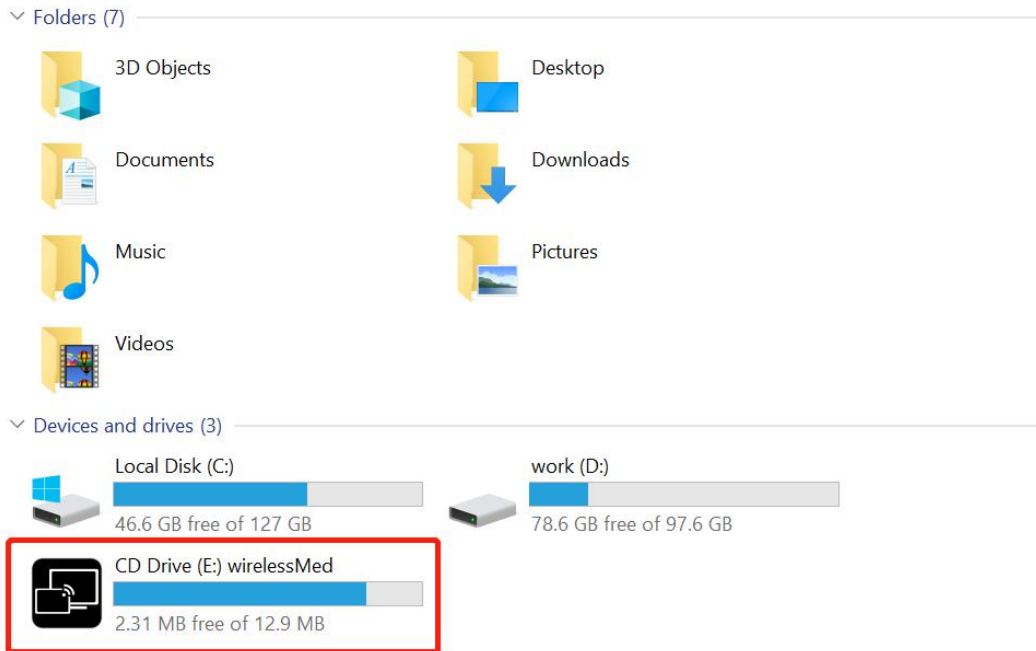

1. Make sure the room USB devices and display are well connected with WU-10 by cables.
2. Refer to **chapter 5.3.1** make sure the laptop is well connected with WU-10 wirelessly in the same network, by HDMI dongle DG-H18 or USB-C dongle DG-C18.
3. Launch VC application such as Zoom from desktop, Choose **Settings>Video>Camera>Meeting Camera**.

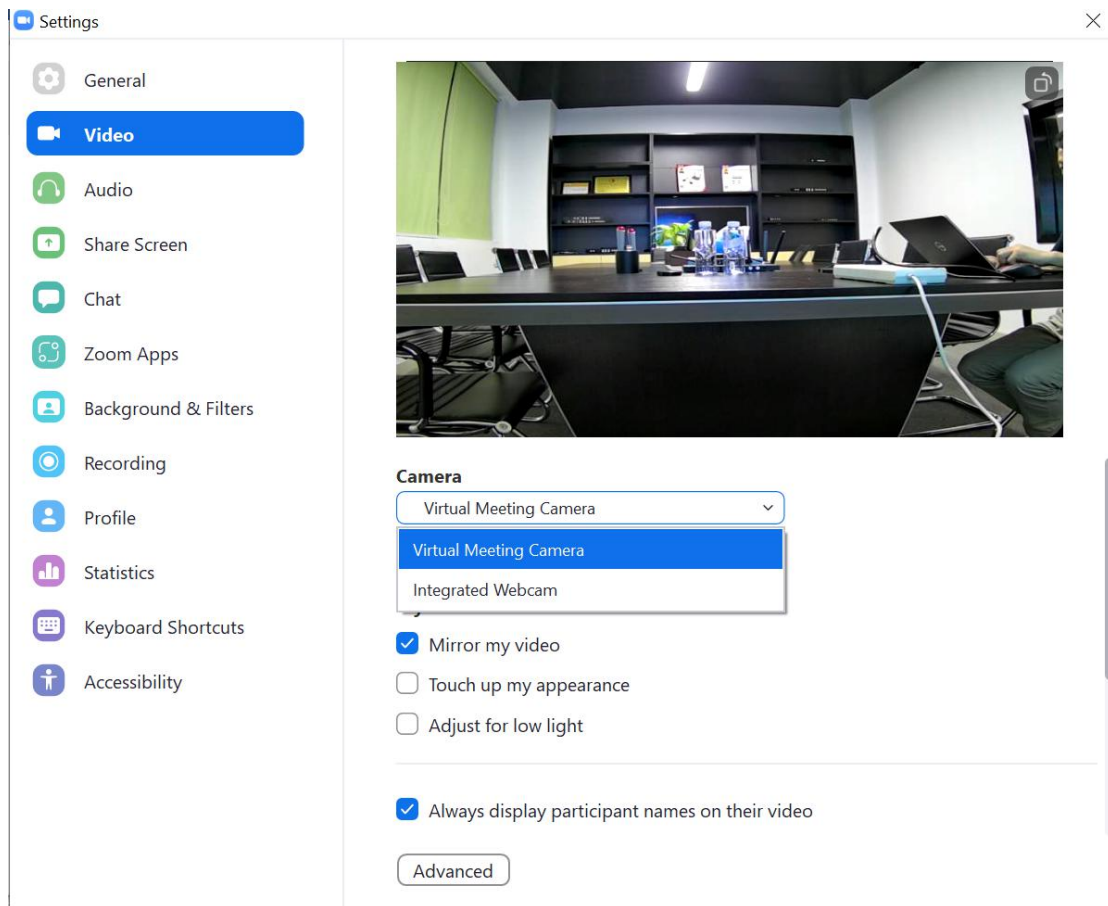

Settings>Audio

For Speaker, select Meeting Audio

For Microphone, select Meeting Audio, too

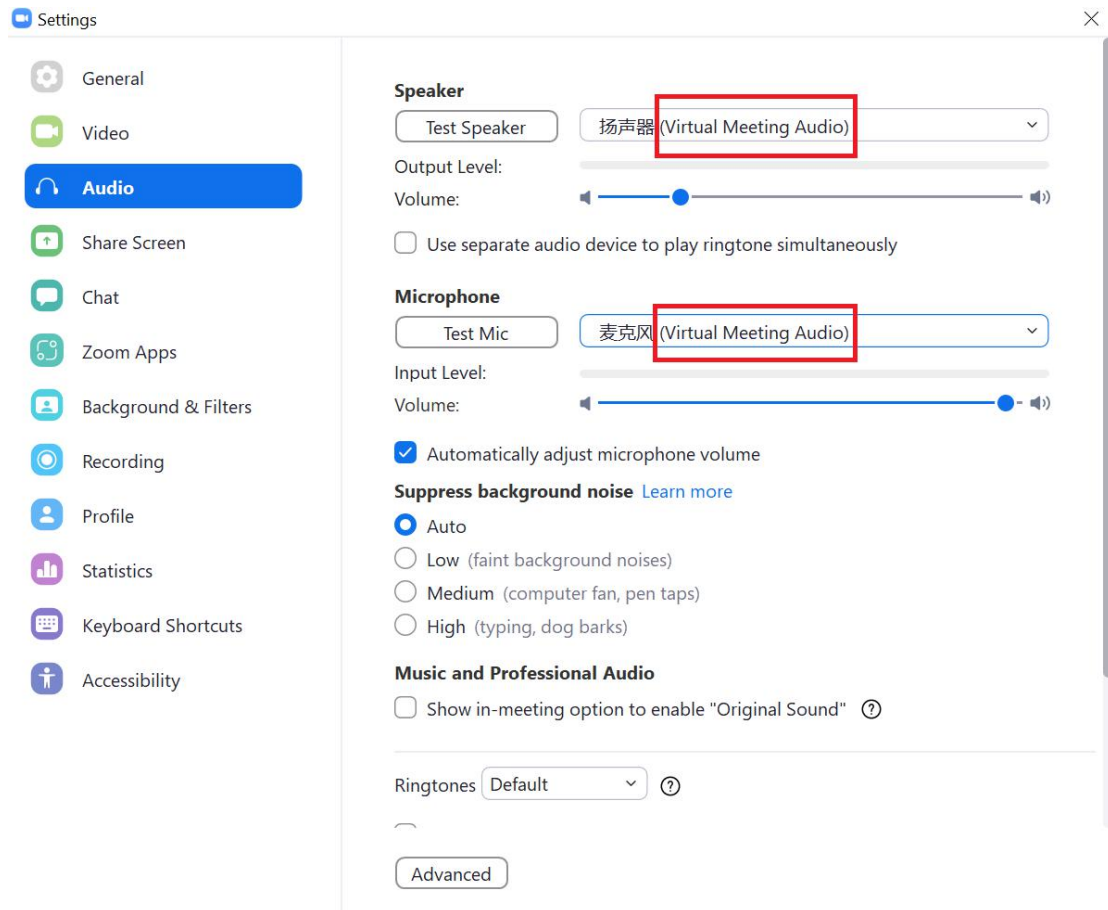

4. Touch the dongle to share the desktop

Now, you are ready to start video conferencing on Zoom with room USB devices.

Note: if application detect the PC and base unit is not in the same network, it will auto pop out an indication to change the network to the base unit's AP. After a few seconds they're connected, the camera, Mic and speaker data will be transferred to the PC; But pls be noted that if the base unit is not accessed to the internet, that will cause the video conference offline.



7. Web Setting Management Configuration

Connect base unit ID & Password or LAN IP to laptop, to enter Wi-Fi IP browser page to configure settings of base unit. The “WirelessMedia-windows.exe” and “WirelessMedia-Pro.exe” for windows PC/Lap-top, “WirelessMedia-macOS.app” for Mac OS X, “user manual” and “WirelessMedia2” for Android can be downloaded here.

Note: after setting, user need to wait for at least 1 min to restart the unit. Otherwise, the modification on the setting will not be saved.

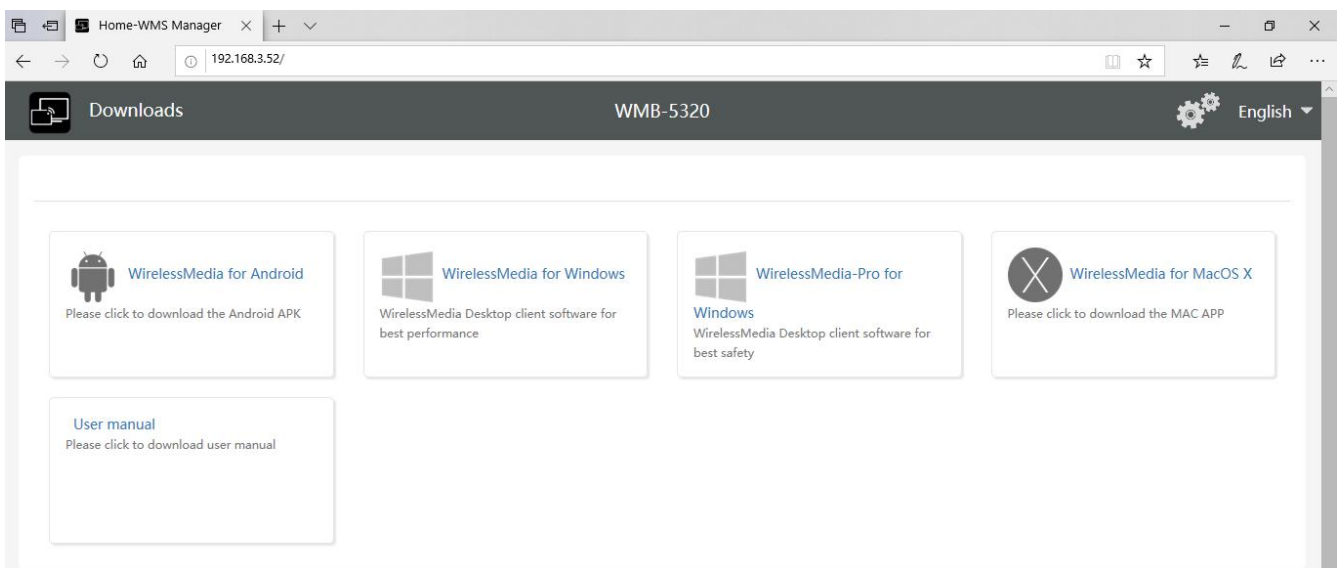

Click Setting button on the top right corner to enter into menu to configure.

A password is required to enter the configuration menu. The default password after Reset is "admin". You can change the password in menu "Security setting".

Note:

If user has forgotten his password, you need to make a Factory Reset to restore “admin” as password.

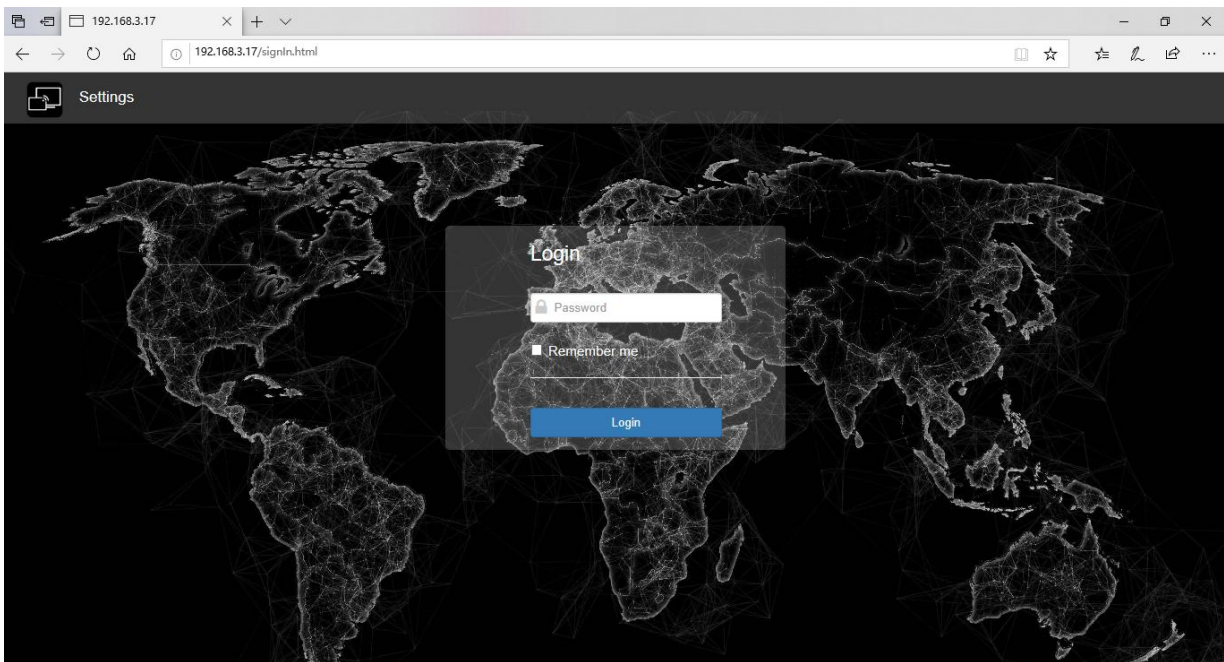
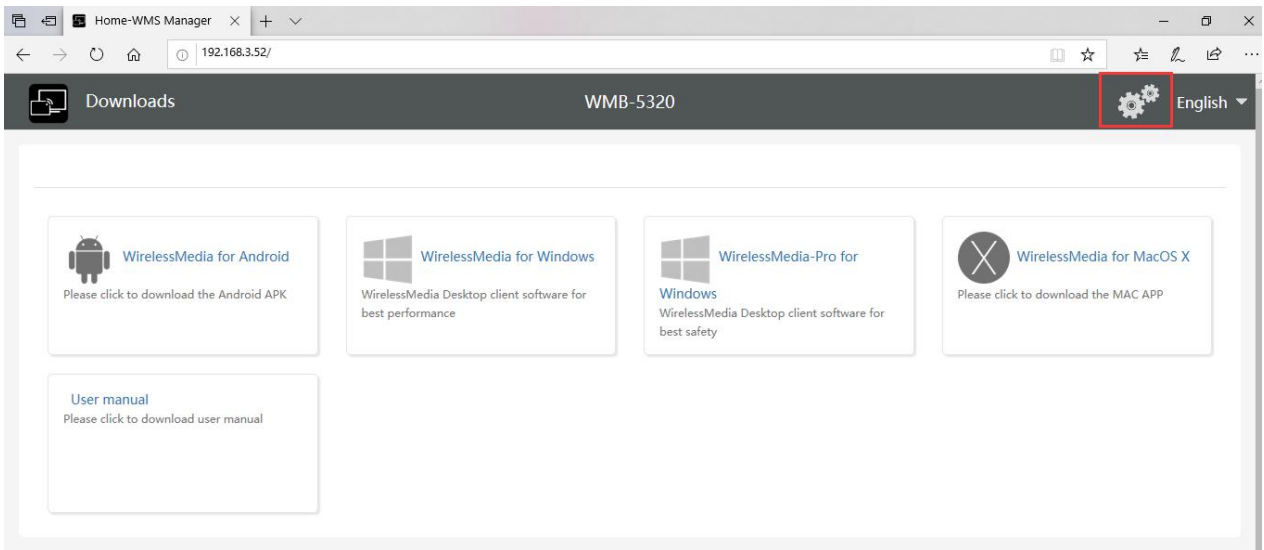

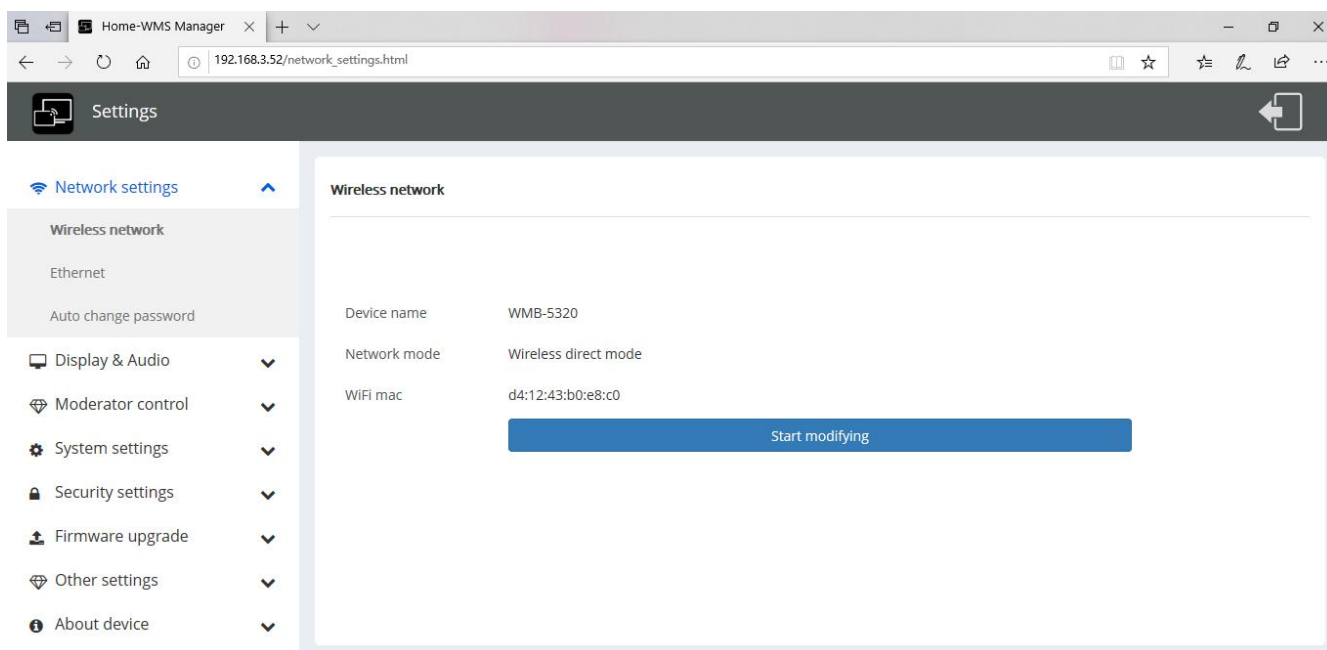

The main interface of Setting is shown as below, including **Network settings, Display & Audio, Moderator control, System settings, Security settings, Firmware upgrade, Other settings, About device.**

7.1 Network settings

7.1.1 Wireless network

To take the full benefits of the WirelessMedia possibilities, WU-10 should be properly integrated in the organization's network (company/university/school). This wizard allows user to create a custom configuration for integration of WirelessMedia into the existing wireless infrastructure in larger organizations.

Segmented Dual Network, is to provide two segmented routing ways to connect to the base unit simultaneously and separately, including wireless WI-FI network (normally connected to Guest/untrusted network) and wired LAN network (normally connected to the corporate/trusted network).

A typical Segmented Dual Network topology is shown as below:

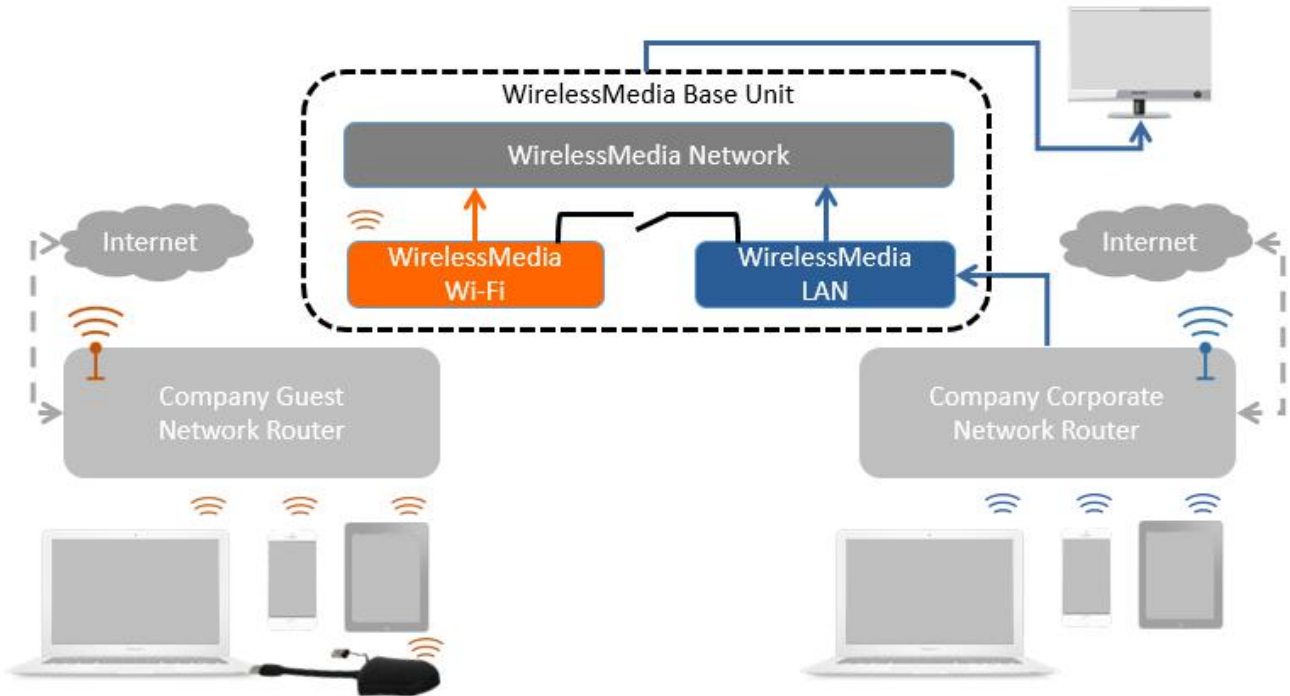

7.1.1.1 Wireless network configuration wizard

Enter a device name for the Base-unit. We recommend to take a descriptive name, if you have more than one WirelessMedia installed. The default name is "WMB-XXXX".

Wireless network

1.Device name 2.Mode selection 3.Network settings 4.SSID setting

Device name WMB-5320

Note The device name is the host name of the device,which is used as the WIFI name when it is set as Wireless Direct Mode,or host name when it is set as Infrastructure Mode. Please pay attention that the changing of ID may cause the re-pairing of the dongle.

Cancel Next step

Only "a-z","A-Z","0-9","-_" and space are legal character.

Click “Next step”. The following three connection methods are available:

wireless network

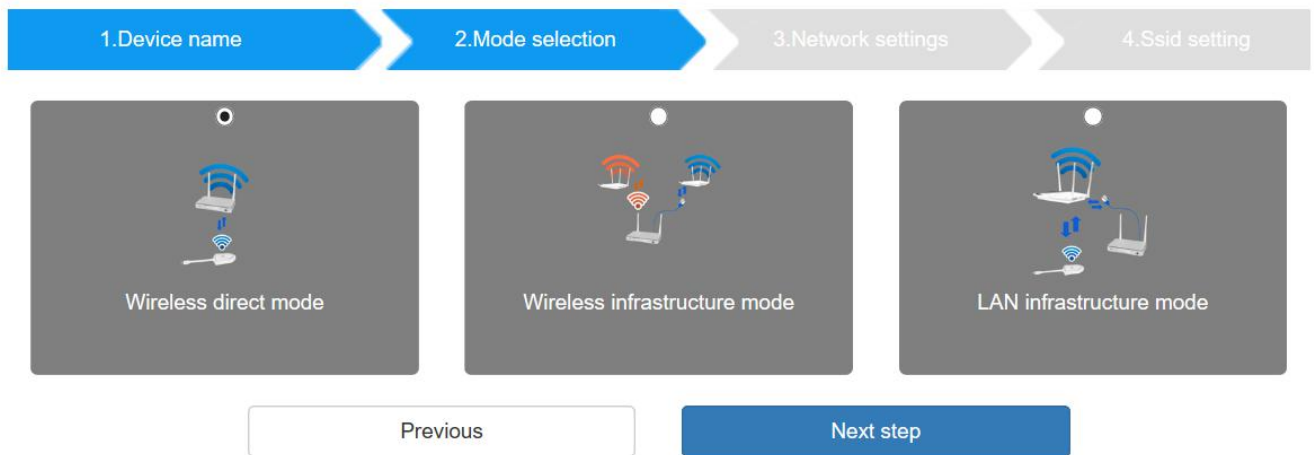

7.1.1.2 Wireless Direct Mode

After Factory Reset, WU-10 base unit starts up in the **default Stand-Alone “Wireless direct mode”**

configuration, where the Base-unit creates its own wireless access point, which all transmitters use to connect. This is typical for a quick setup for small group meetings. The Wi-Fi icon  for the “Wireless direct mode” is displayed in top status-bar of Home screen. **Guest** connect to the access-point of WU-10, while **Staff** can also connect to Base-unit via Wi-Fi or via LAN connection to their corporate network.

Stand-Alone Connection

The internal Wi-Fi access Point of WU-10 is active . The dongle is paired directly to it. Guest and Staff use the internal Wi-Fi access point of Base-unit to present with all their units. **No Internet access is required.**

The LAN-Port of Base-unit is not connected. The PC-users can present with or without dongle by

WirelessMedia PC driver (Windows or MacOS). Android users (BYOD) can share their content by installing the free APP on their device and IOS users can use AirPlay (Apple only).

Recommended Environment

This option is best for temporary operation, small installations, and rooms without network access or networks

that do not allow network access for Guests, due to strict security concerns, and are completely separate from the corporate network.

Under this mode, dongle will be automatically paired to the base unit Wi-Fi hotspot when plugging dongle to the base unit USB port for pairing.

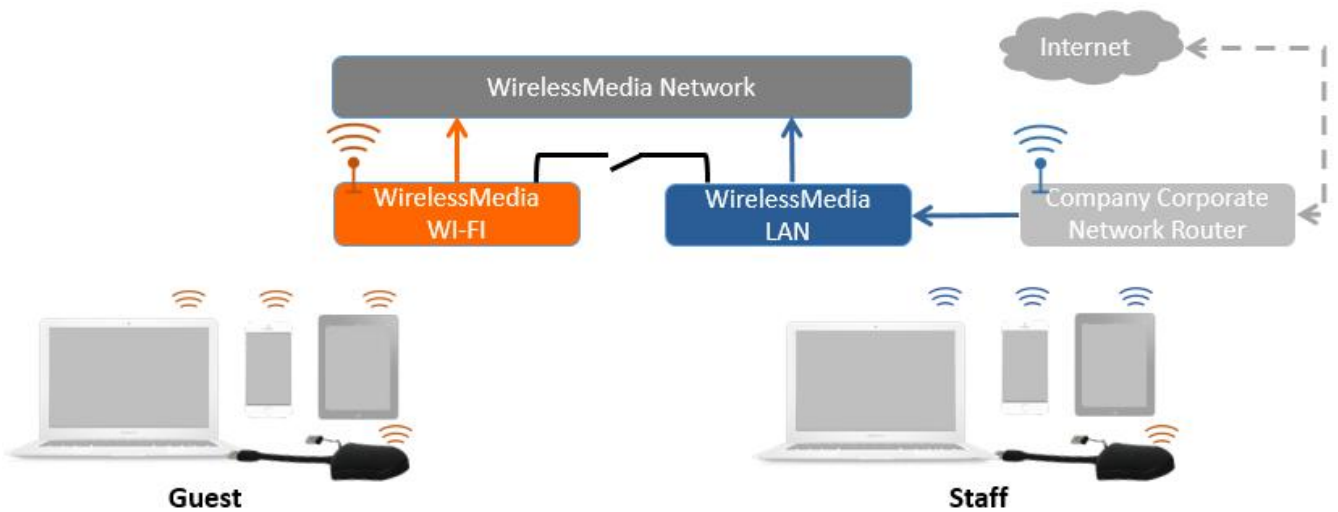

You can start using WU-10 in this mode without any other wireless network configuration.

Click “Next step” to

Set up Wi-Fi access point

Set-up Wi-Fi access point includes, Frequency, Channel, Password.

Wireless network

1. Device name 2. Mode selection 3. Network settings 4. SSID setting

Allow internet access (bridging) via LAN 1 Allow internet access (bridging) via LAN 2 Disable internet access

SSID discovery and connection: Yes

Frequency: 5GHz

Channel: 149

Password: ●●●●●●

Previous Next step

- **Frequency:** Click to select 2.4 GHz or 5 GHz Wi-Fi frequency. Default is 5 GHz.
- **Channel:** Click to select the Wi-Fi channel. Default is 5 GHz, Auto.

If the Wi-Fi channel is changed, no new pairing of the dongle is necessary.

2.4 GHz frequency band: channels 1, 2, 3, 4, 5, 6, 7, 8, 9, 10, 11,

5 GHz frequency band: no need to choose 5G channel, system will choose proper channel automatically.

Default is 5 GHz, channel: Auto.

Default channel (USA area): 36,40,44,48 or 149,153,157, 161. Four channels will be opened at the same time, system will automatically choose proper channel from them.

Default channel (European area): 36,40,44,48.

Default channel (China): 149,153,157,161.

- **Password:** Click in the input field to fill out the appropriate password with length of **8 characters**.

Click “Next step” to edit or change Guest network SSID and STAFF network SSID. This information will be shown at Home Screen of WirelessMedia.

Wireless network

1. Device name 2. Mode selection 3. Network settings 4. SSID setting

GUEST network SSID:

STAFF network SSID:

Click “Submit settings” to finish configuration.

After it please re-pairing dongle with the base unit.

There are 3 ways of connecting the base unit to Internet through Base unit in “Wireless Direct Mode”.

- Allow internet access (bridging) via LAN 1: able to connect to Internet if LAN1 port is available.
- Allow internet access (bridging) via LAN 2: able to connect to Internet if LAN2 port is available.
- Disable internet access: cannot be on Internet if choose this mode. (For safety concern)

Wireless network

1.Device name 2.Mode selection 3.Network settings 4.SSID setting

Allow internet access (bridging) via LAN 1

Allow internet access (bridging) via LAN 2

Disable internet access

SSID discovery and connection: Yes

Frequency: 5GHz

Channel: 149

Password: [masked]

Previous Next step

7.1.1.3 Wireless Infrastructure mode

Wireless network

1.Device name 2.Mode selection 3.Network settings 4.SSID setting

Wireless direct mode

Wireless infrastructure mode

LAN infrastructure mode

Previous Next step

WirelessMedia can connect to a wired and a wireless network simultaneously. The basic unit is firmly "connected to the company network with LAN. Guest users connect to Wi-Fi "Guest" access. The employees ("Staff") connect to their usual access point of the corporate network, without having to change the Wi-Fi. This is very useful for

organizations, which have a wireless “Guest” network for external visitors and a wired “Staff” network for their employees. The segmented Dual Network of WirelessMedia provides two separated routing ways to connect to the Base-unit at same time. Guest-users are not able to access any resource on the Ethernet of the company.

WirelessMedia uses the existing wireless network infrastructure. Guest and Staff have internet access.

Dual Network Configuration

The internal the Wi-Fi network of WirelessMedia is connected to Guest Wi-Fi network of the organization,

(Client

Mode: the indicator-icon  shows the actual signal strength). The Base-unit is still wired with LAN-cable to the internal company network

The PC-users can present, with or without dongle TOUCH by WirelessMedia PC driver (Windows or MacOS).

Android users can share their content by installing the free APP, IOS users can use AirPlay to share content (Apple only).

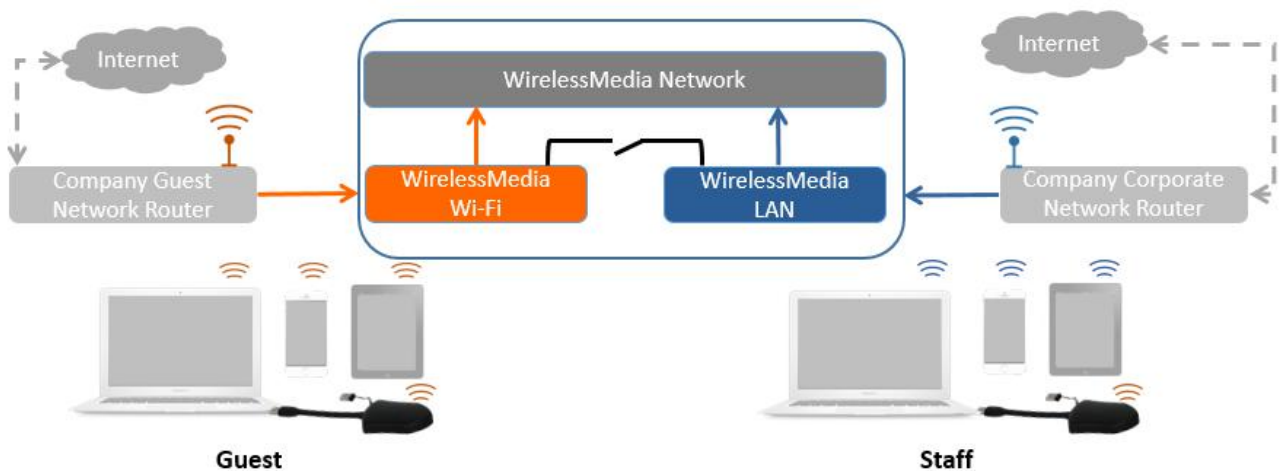

The dongle is connected to the Wi-Fi access Point of Guest network, which in turn is connected to the

internal Wi-Fi access Point of WirelessMedia. (The dongle can also be configured to connect to the enterprise's access point.) Mobile users stay connected to their current network, have access to their normal corporate environment, as well as Internet access.

The actual received signal strength from Guest network is shown in Home screen of WirelessMedia:  .

Follow the instructions of the configuration wizard for “Wireless infrastructure mode”. When pairing the dongles, by plugging the dongle in the USB port of the Base-unit, it will automatically pair to the associated access point of Guest or Staff Wi-Fi and NOT to WirelessMedia.

Click “**Next step**” to configure the network which dongle needs to be paired to.

“Dongle connects to base unit via wireless network.”

Choose a wireless network which is separate from the company LAN network for guest users.

Select SSID: Choose a wireless network to connect to base unit for guest.

Password: enter password to connect the base unit to the guest network.

Wireless network

1.Device name 2.Mode selection 3.Network settings 4.SSID setting



Dongle connects to base unit via wireless network

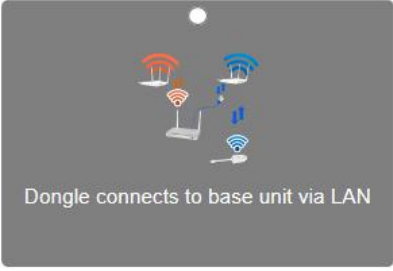

Dongle connects to base unit via LAN

5GHz ONLY

Select SSID: ✓

Password: ✓

Click “Next step” to edit or change Guest network SSID and Staff network SSID.

Wireless network

1.Device name 2.Mode selection 3.Network settings 4.SSID setting

GUEST network SSID:

STAFF network SSID:

Wi-Fi name of guest and staff will be shown on home screen after “Submit settings”.

After submitting successfully, please re-pair dongle with base unit.

“Dongle connects to base unit via LAN.”

Choose a LAN network which is used for the company staff users.

Note: usually in this mode, dongle paired for internal staff usage.

Select SSID: Choose a wireless network to connect to base unit for guest.

Password: enter password to connect the base unit to the guest network.

Select dongle SSID: choose the same LAN network which base unit connects, to pair the dongle.

Password: enter password of the LAN network.

See picture as below:

Wireless network

1. Device name 2. Mode selection 3. Network settings 4. SSID setting

Dongle connects to base unit via wireless network

Dongle connects to base unit via LAN

5GHz ONLY

Select SSID: Grastron_Guest_5.0G (SignalLevel:59%) Rescan List ✓

Password: ●●●●●●●● ✓

Select dongle SSID: Grastron_5.0G (SignalLevel:99%) Rescan List ✓

密码: ●●●●●● ✓

Previous Next step

Click “Next step” to edit or change Guest network SSID and Staff network SSID.

Wireless network

1. Device name 2. Mode selection 3. Network settings 4. SSID setting

GUEST network SSID:

STAFF network SSID:

Wifi name of guest and staff will be shown on home screen after “Submit settings”

After submitting successfully, please re-pair dongle with base unit.

7.1.1.4 LAN Infrastructure Mode

Wireless network

1. Device name 2. Mode selection 3. Network settings 4. SSID setting

Wireless direct mode Wireless infrastructure mode LAN infrastructure mode

In this configuration the **built-in Wi-Fi** access point of WirelessMedia **is disabled:**  .

The dongle and/or the mobile devices can connect to the secured wireless access point of the company network. The Base-unit of WirelessMedia is hard-wired connected via LAN to the Ethernet of the Company network.

The Staff-users connect to their usual access point of Company network, without the need to change the Wi-Fi.

Follow the instructions of the configuration wizard for “LAN infrastructure mode”.

When pairing the dongles, by plugging the dongle in the USB /Type C port of the Base-unit, will be automatically paired to the Staff access point, and NOT to “WirelessMedia” Base-unit.

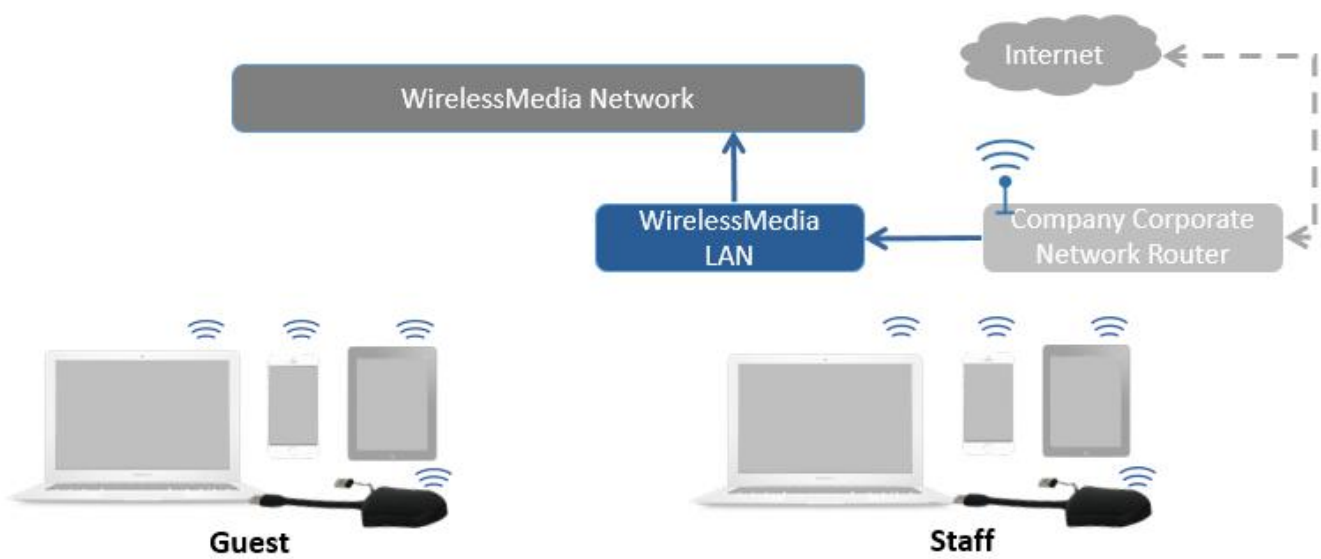

Click “Next step” to choose a LAN network which is used for the company staff users and pair the dongle into this network.

Wireless network

1. Device name 2. Mode selection 3. Network settings 4. SSID setting

5GHz ONLY

Select Sid: Grastron_5.0G (SignalLevel:99%) Rescan List ✓

Password: ●●●●●● ✓

Previous Next step

Click “Next step” to edit or change Guest network SSID and Staff network SSID.

Wireless network

1. Device name 2. Mode selection 3. Network settings 4. SSID setting

GUEST network SSID: Grastron_Guest_5.0G

STAFF network SSID: Grastron_5.0G

Previous Submit settings

Wifi name of guest and staff will be shown on home screen after “Submit settings”

After submitting successfully, please re-pair dongle with base unit.

7.1.2 Ethernet

Configure the Ethernet settings. WU-10 has 2 Lan port, if the base unit is connected with 2 LAN cable, you can configure from below tab.

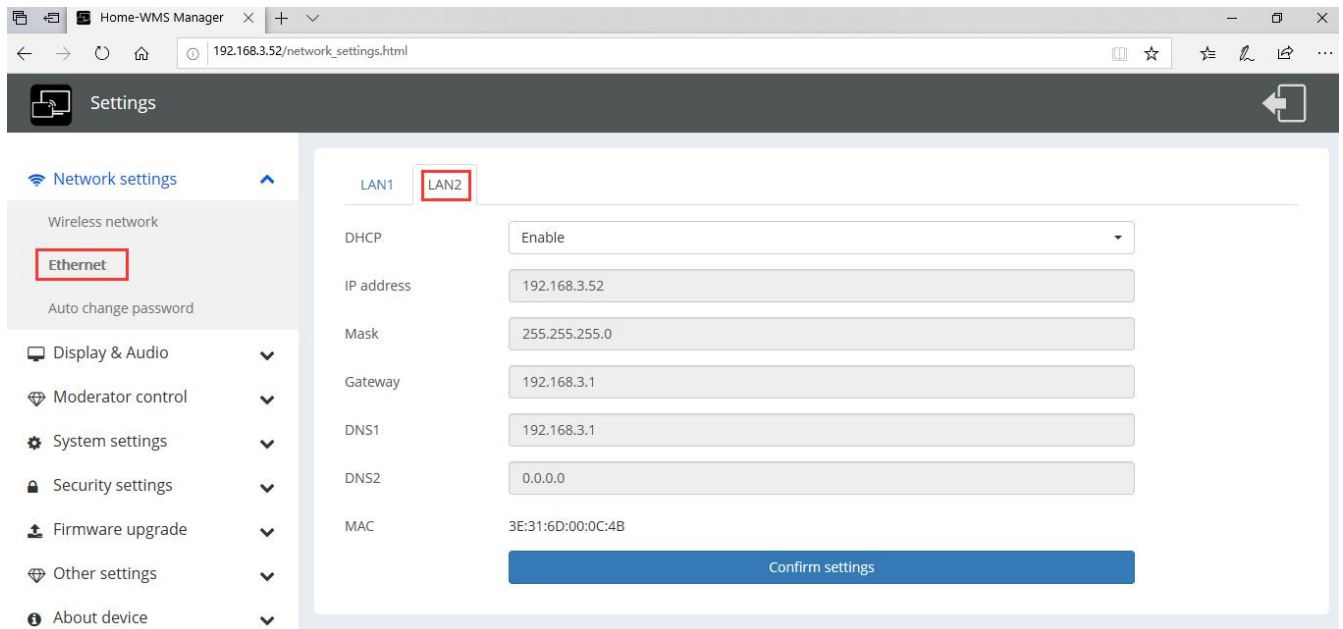
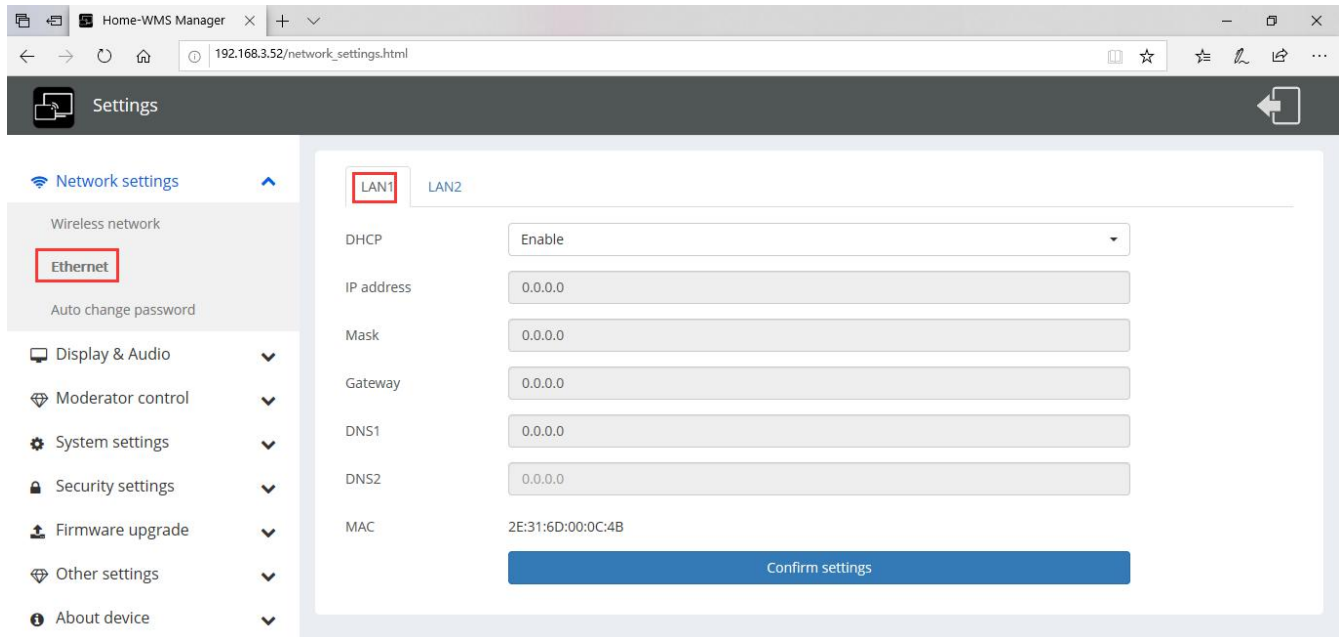

7.1.3 Auto change password

The password remains unchanged for all participants of the meeting, while at least one dongle or a Wi-Fi network of a mobile device are connected with Base-unit. After the user is disconnected, a configurable time runs.

- The changeable password will be fixed by connecting a dongle to PC/Laptop or connect a mobile unit to the Wi-Fi of the Base-unit, and continue to be changeable after 15s after disconnecting the last dongle or disconnect the Wi-Fi of a mobile unit.
- User do not need to re-pair the dongle again, if only the password is changed. A **Smart mobile device** has to enter the correct SSID and password to connect to the Base-unit access point, in order to access all functionality.

Configure to automatically change Wi-Fi password to a random number every period of time.

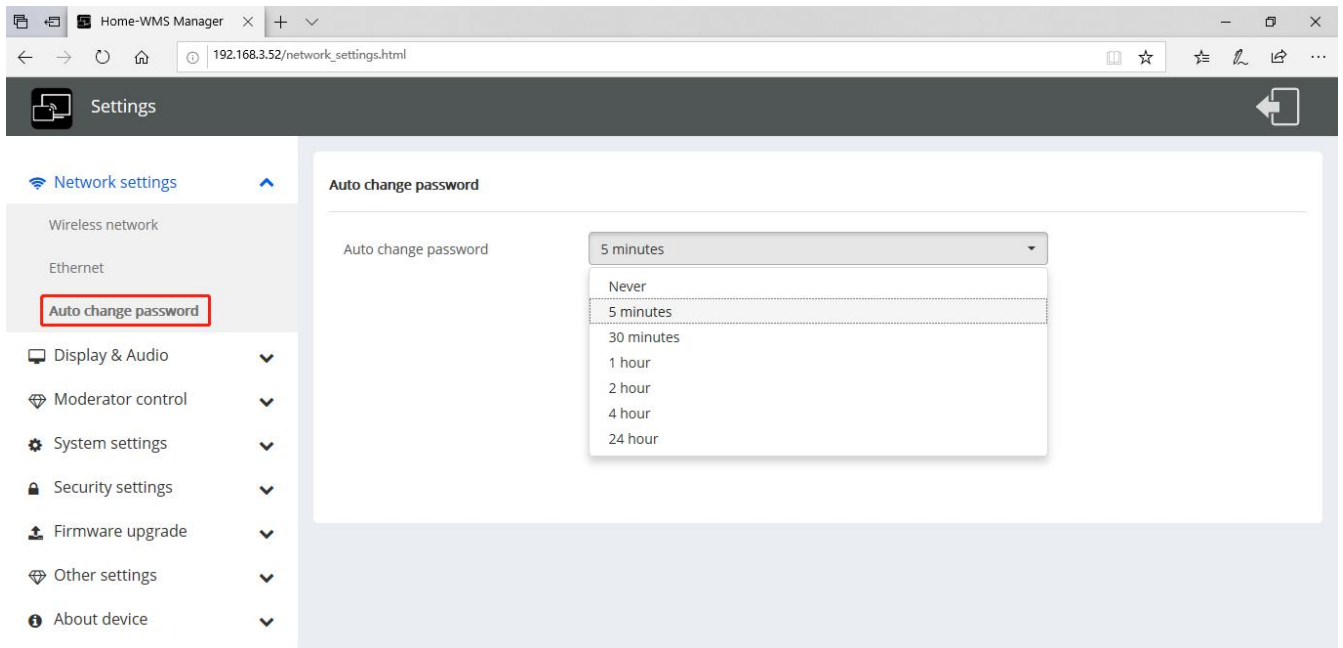

Click to set the configuration, including

- **Never:** never change Wi-Fi password. (Even after POWER-OFF condition)
- **5 minutes:** change Wi-Fi password every 5 minutes.
- **30 minutes:** change Wi-Fi password every 30 minutes.
- **1 hour:** change Wi-Fi password every 1 hour.
- **2 hours:** change Wi-Fi password every 2 hours.
- **4 hours:** change Wi-Fi password every 4 hours.
- **24 hours:** change Wi-Fi password every 24 hours.

7.2 Display & Audio

7.2.1 HDMI

HDMI Resolution

Select the resolution at HDMI output of Base-unit.

Existing HDMI output resolution as below:

- Auto
- 3840x2160 @30Hz
- 3840x2160 @60Hz
- 3840x2160 @50Hz
- 1920x1080 @60Hz
- 1920x1080 @50Hz

- 1280x720 @60Hz
- 1280x720 @50Hz

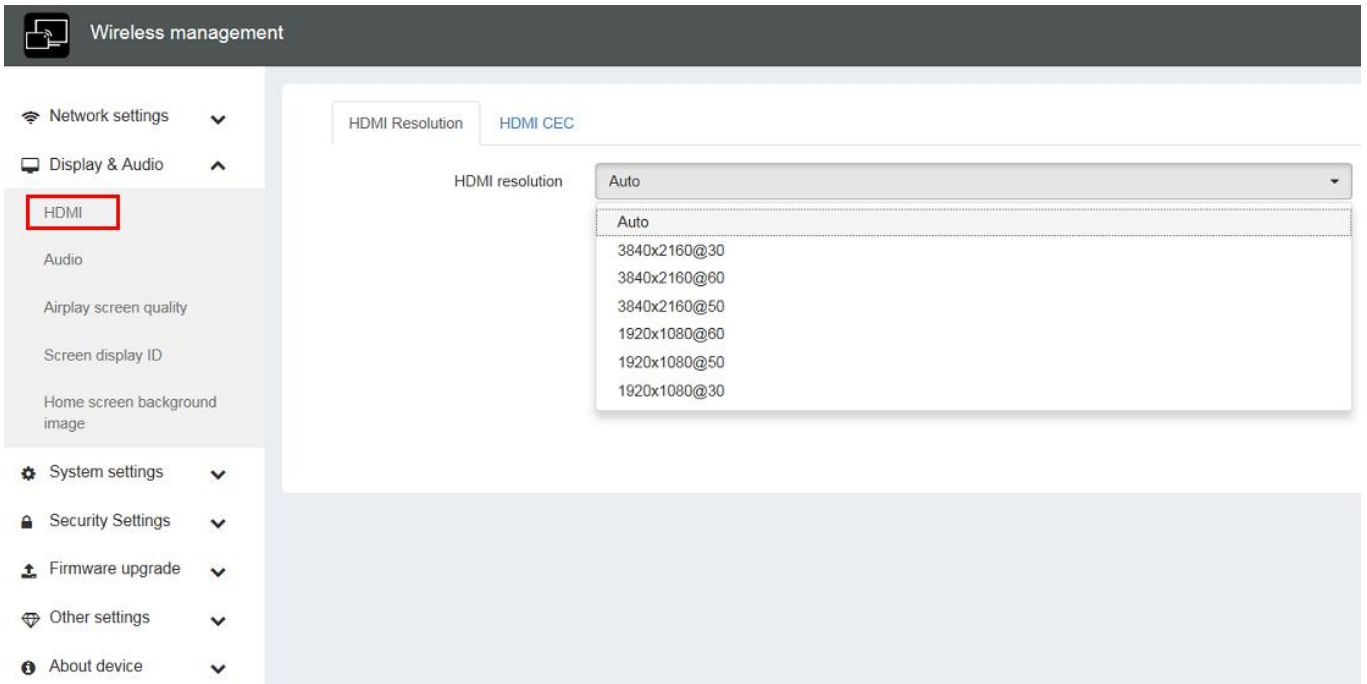

Note: if the display is only support FULL HD, the 4K resolution will not be shown on the list of the below resolution.

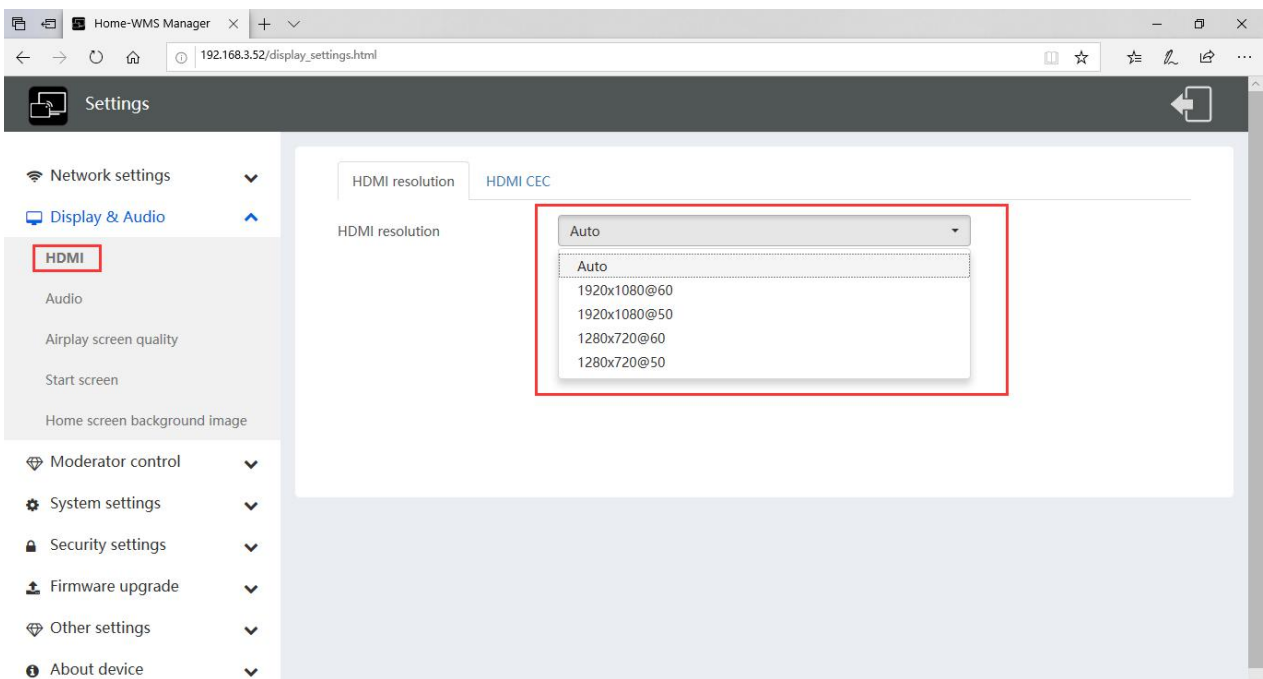

HDMI CEC

Base unit support CEC function if the connected display support CEC function.

Note: when you find the HDMI CEC doesn't work, you need to check whether monitor supports CEC feature or not, since some brand model monitor doesn't support CEC.

- **Device auto power off:**
 - ON (Default): When base goes into standby, it will send commands via the HDMI cable to make the connected monitor into standby also. If off "Device auto power-off", there is no commands are sent to standby the connected monitor.
 - OFF: Display will not automatically turn off when base unit is powered off.
- **Auto turn off base unit when display is turned off:**

When monitor into standby, it will send commands via the HDMI cable to make the connected base unit into standby also. The option menu is to ON/OFF whether "Base unit auto power-off" or not.

- On: Base unit will be auto turned off also when display is turned off.
- Off (Default): Base unit will not be auto turned off also when display is turned off.

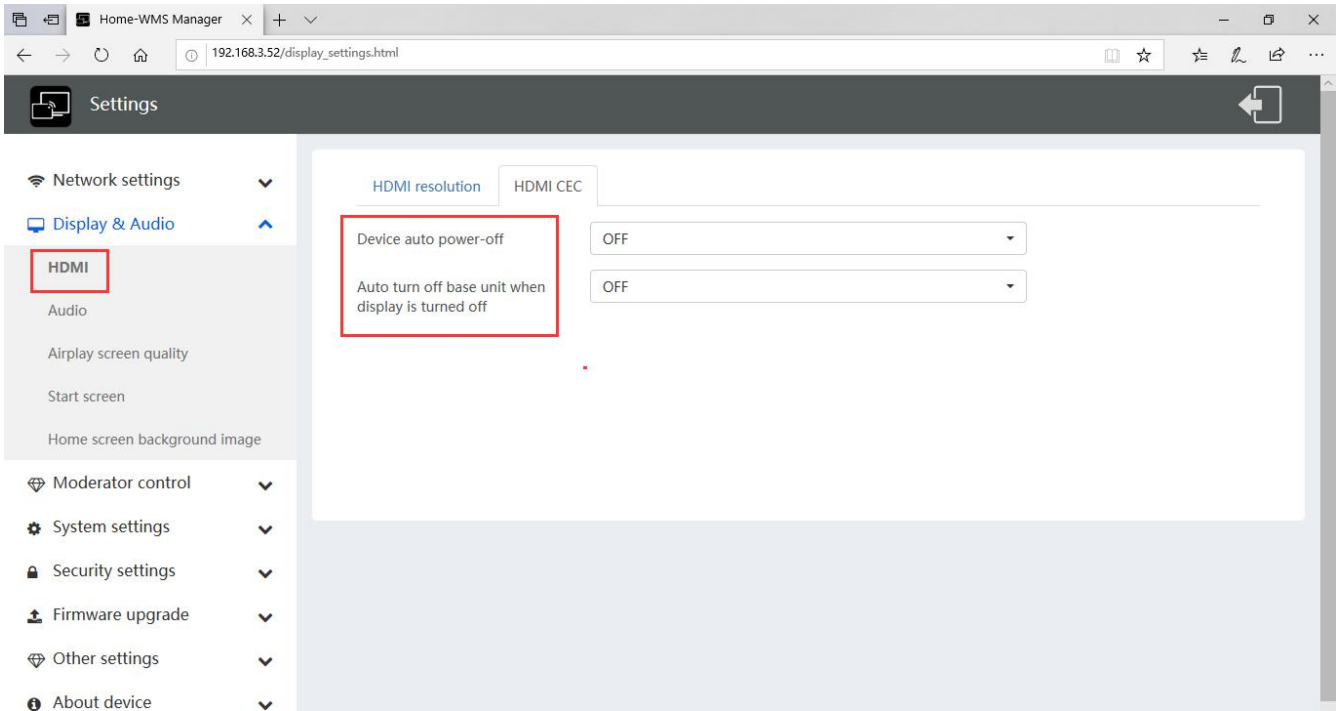

7.2.2 Audio

Audio

Choose audio output:

Jack: output only 3.5mm mini-jack audio.

HDMI: output only HDMI audio.

Jack&HDMI (Default): output Jack & HDMI audio

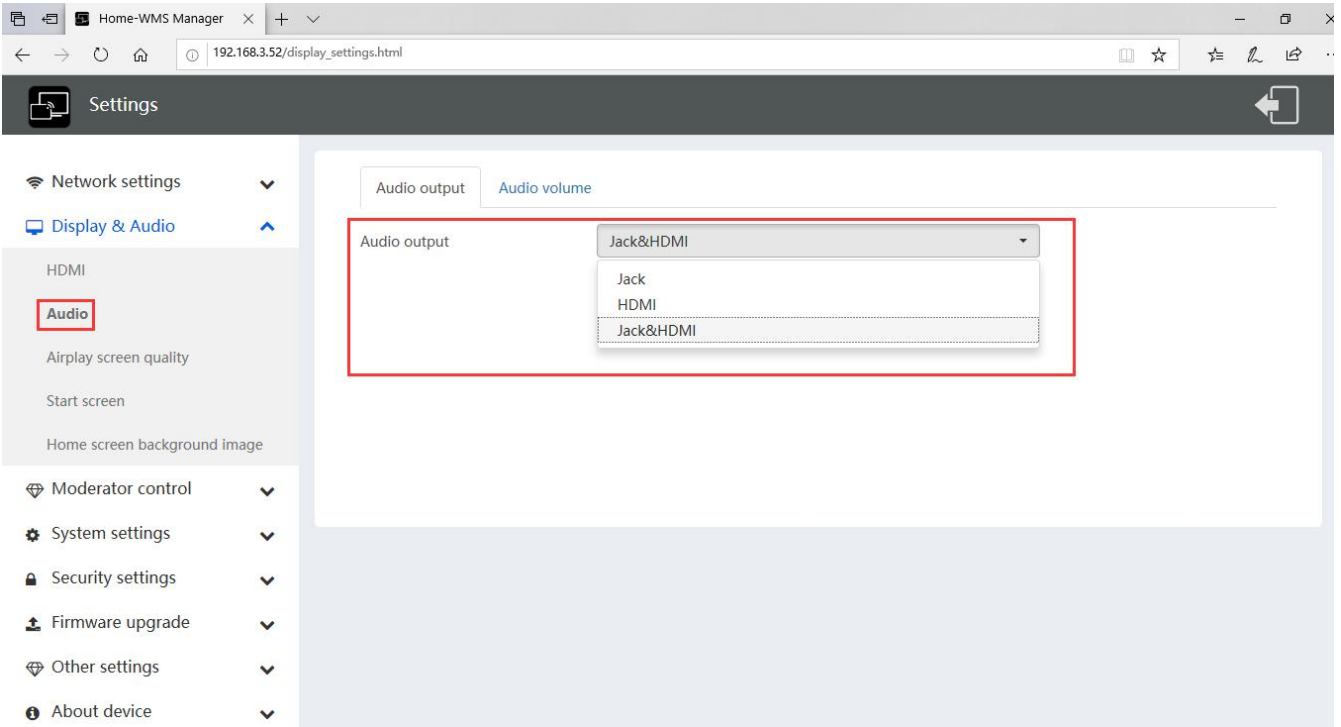

Volume

User can select volume of display from 0 to 100.

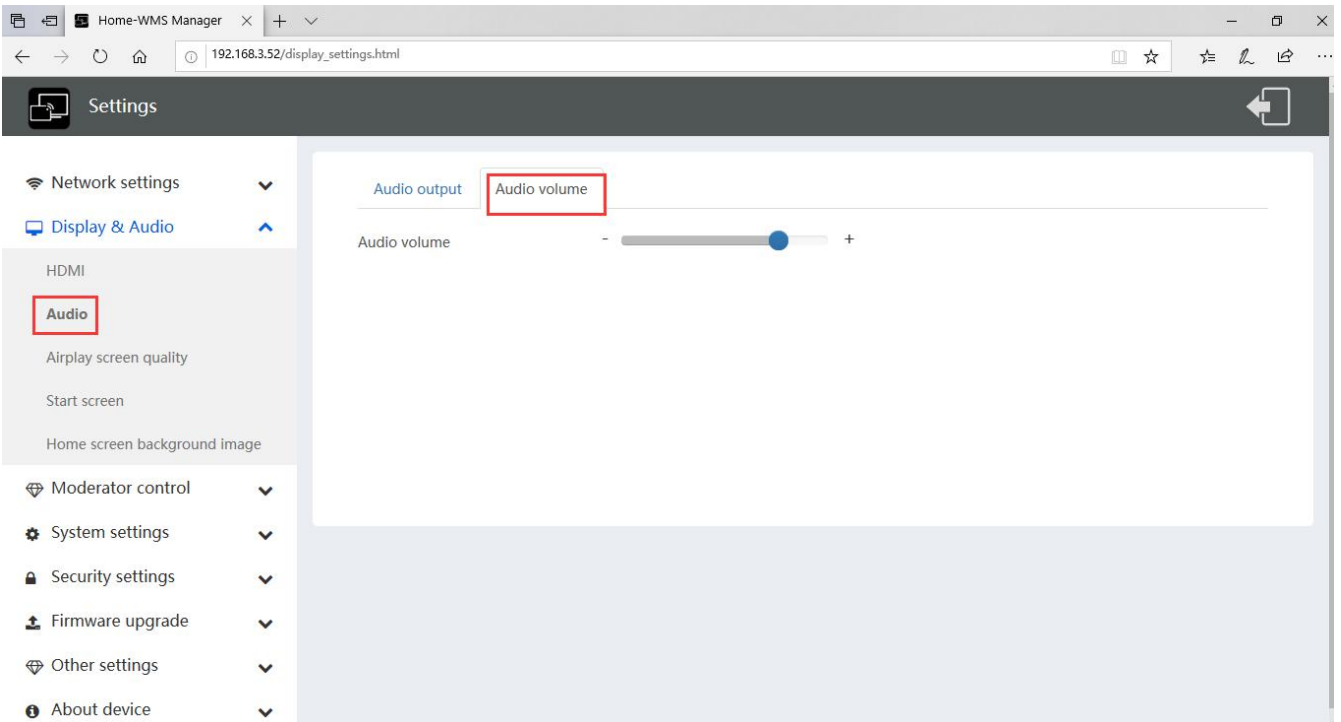

7.2.3 Airplay screen quality

Click to select the image quality when transmit apple device by “AirPlay” mode.

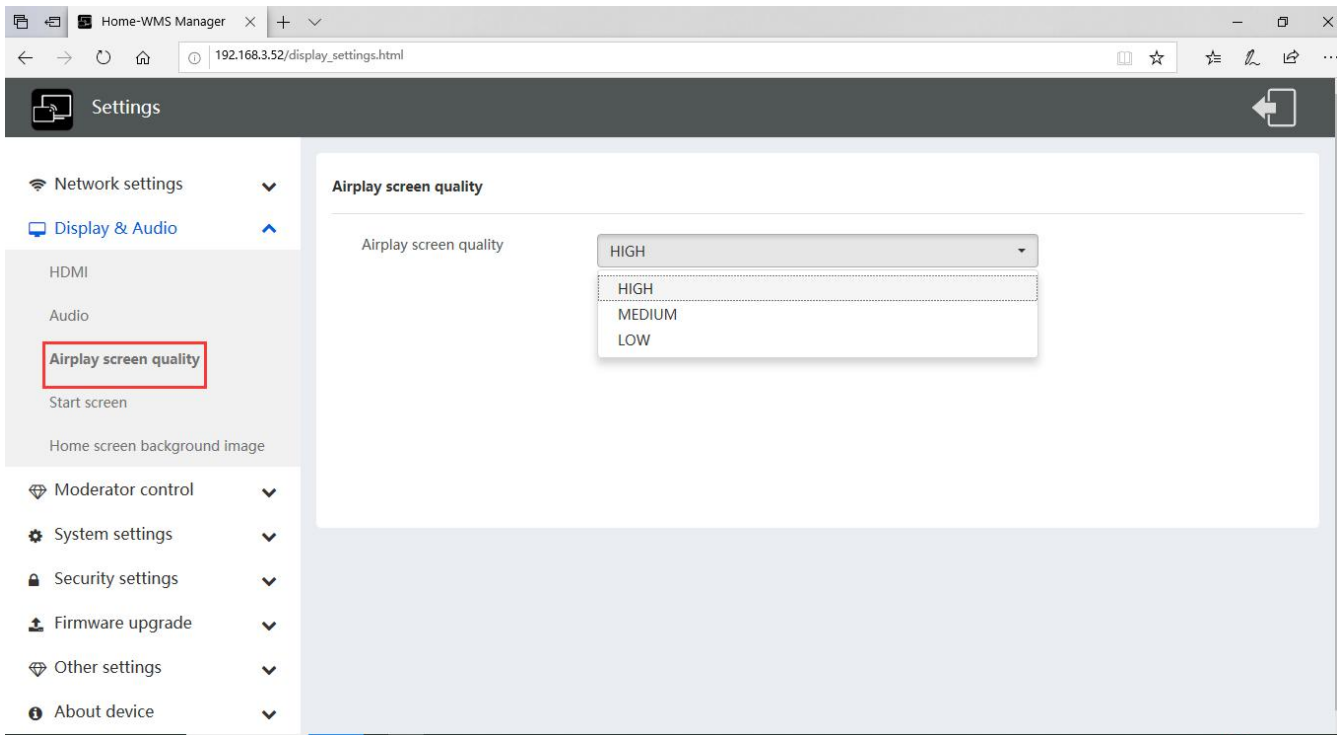

7.2.4 Start screen

- **Show device name and password when mirroring:** Name (ID) and Wi-Fi-password can be shown or hidden at top status-line of **main screen**.

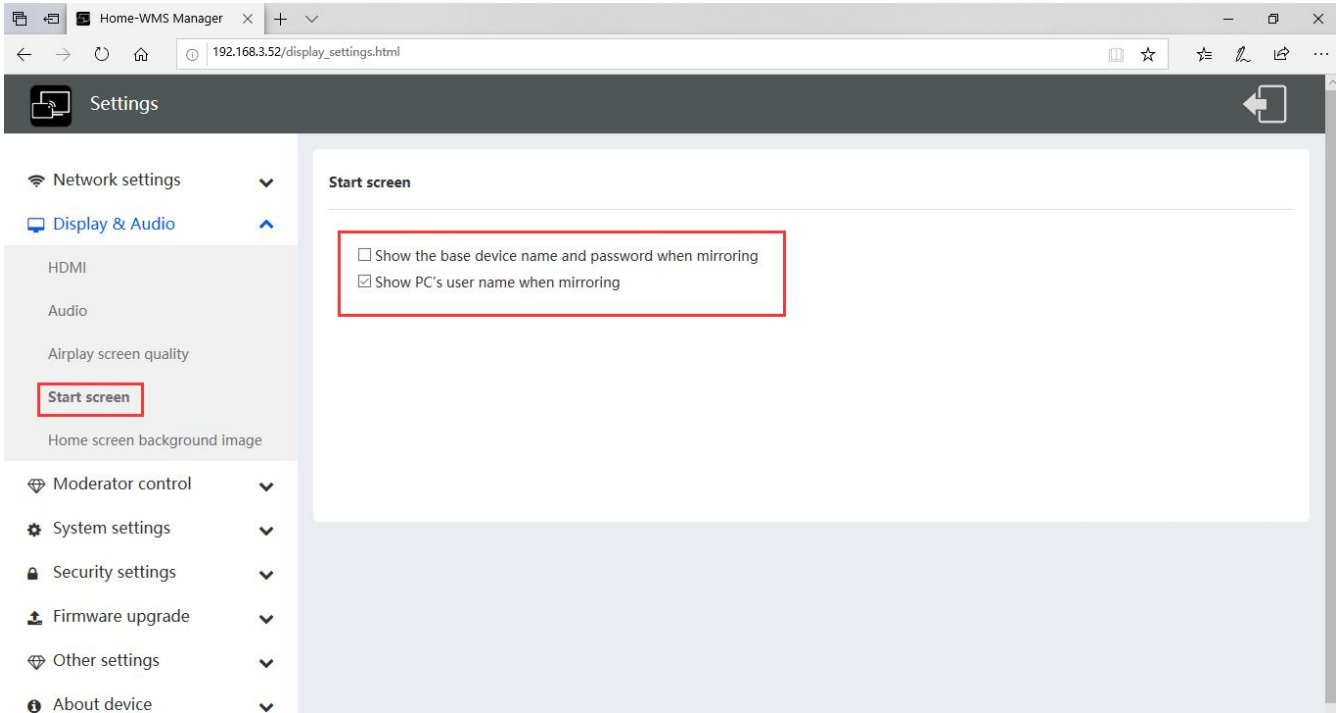

- **Show PCs user name when mirroring.**

Show user name.

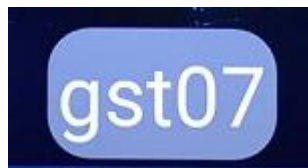

7.2.5 Home Screen background image

When powering WirelessMedia the start screen will be displayed. User can change background image of Home screen. Select the image (jpg, bmp, png, gif with resolution 1920x1080 p.) from suitable directory and activate box for selection. You can return to Standard Home screen every time.

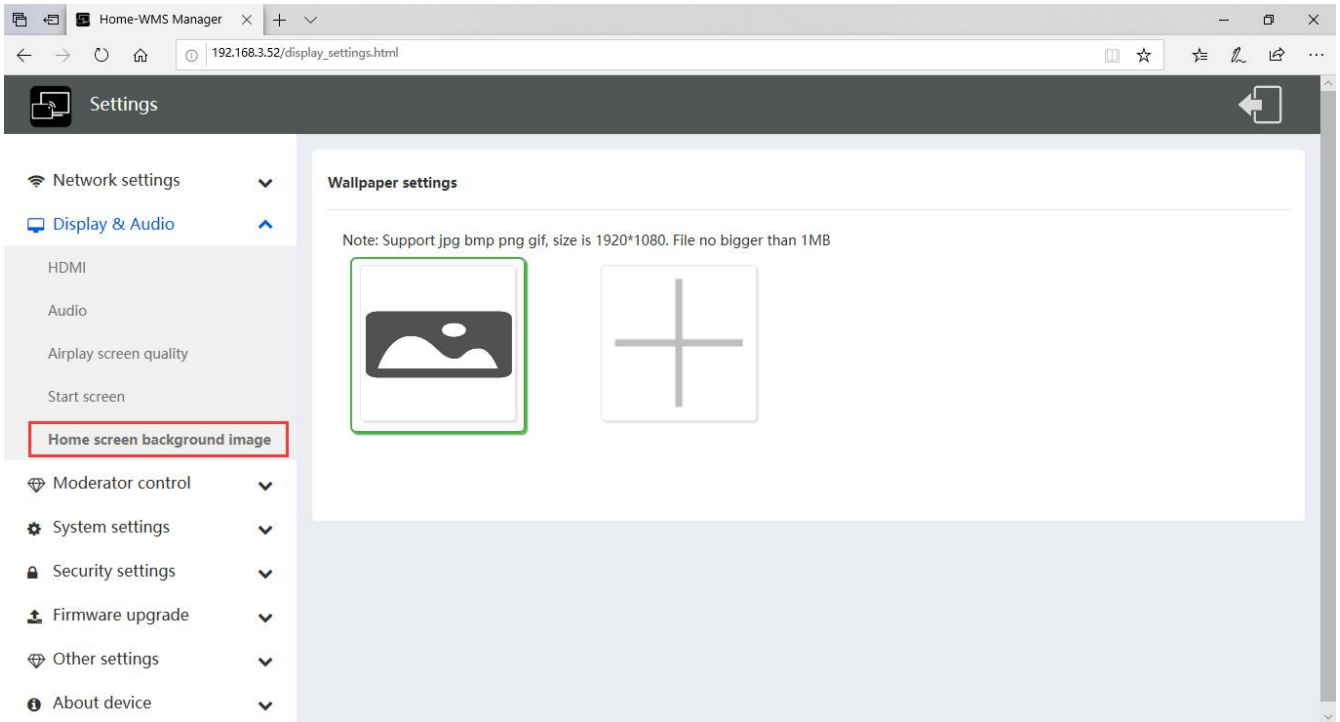

7.3 Moderator control

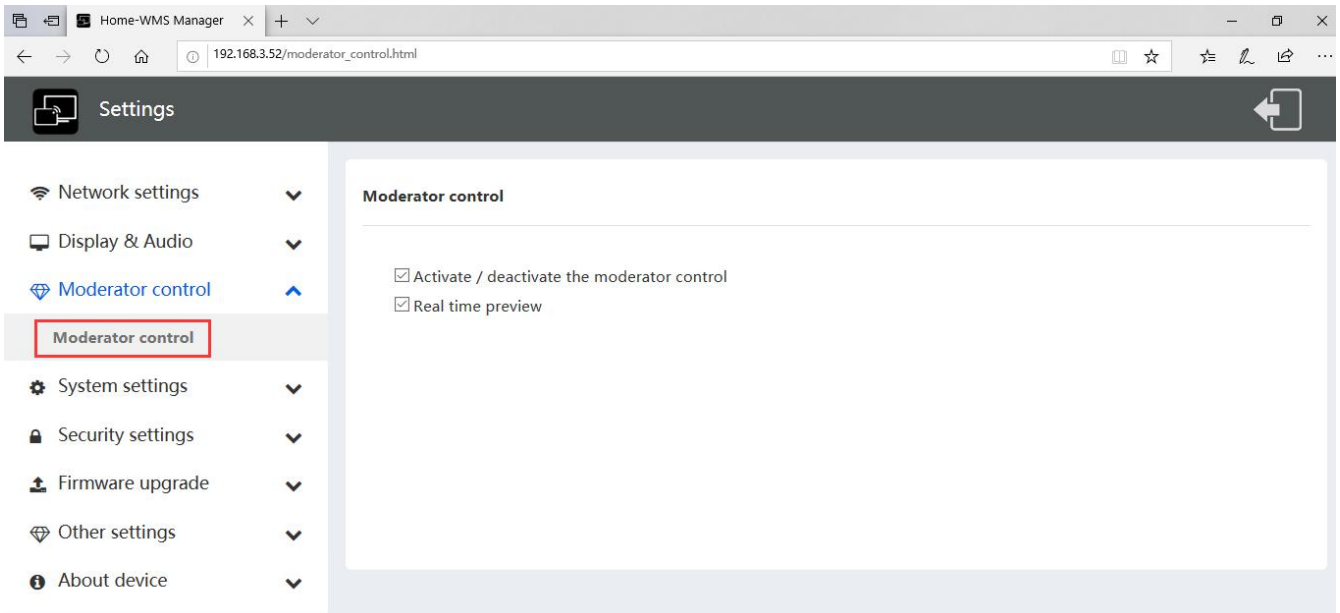

- Add a sub-window bar to enable previewing the connected devices. Tick the icon, it will show the sub window as below once devices are connected to base unit.

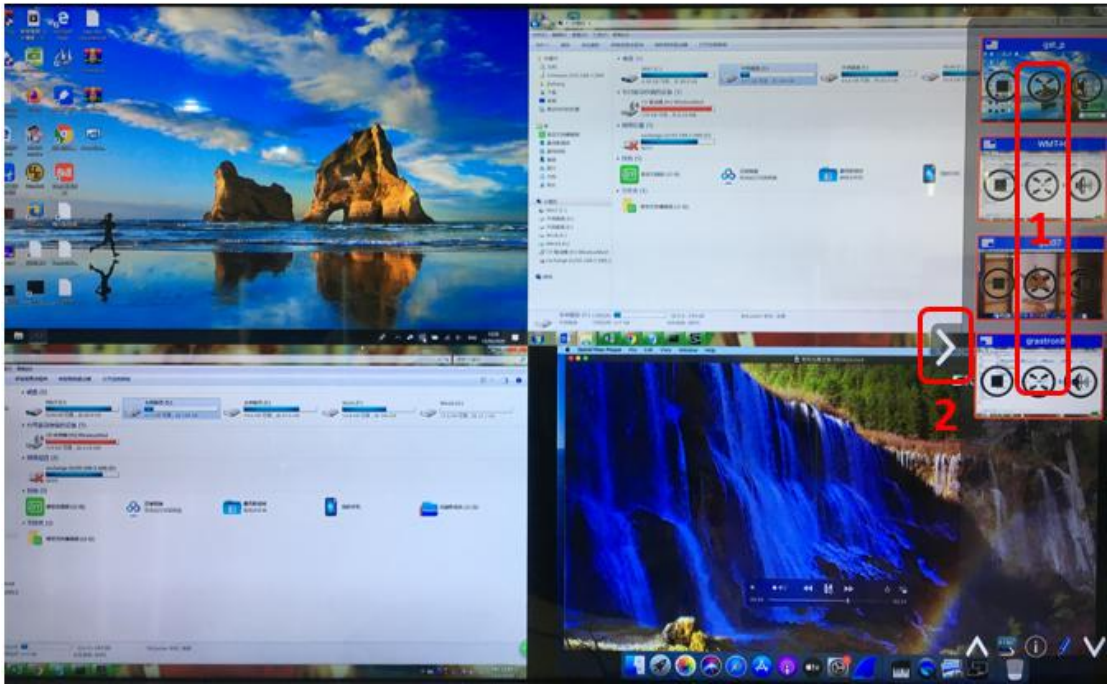

- Real time preview

If tick the icon, the preview window will show real time preview, if not tick, the preview window will only show a static picture as below.

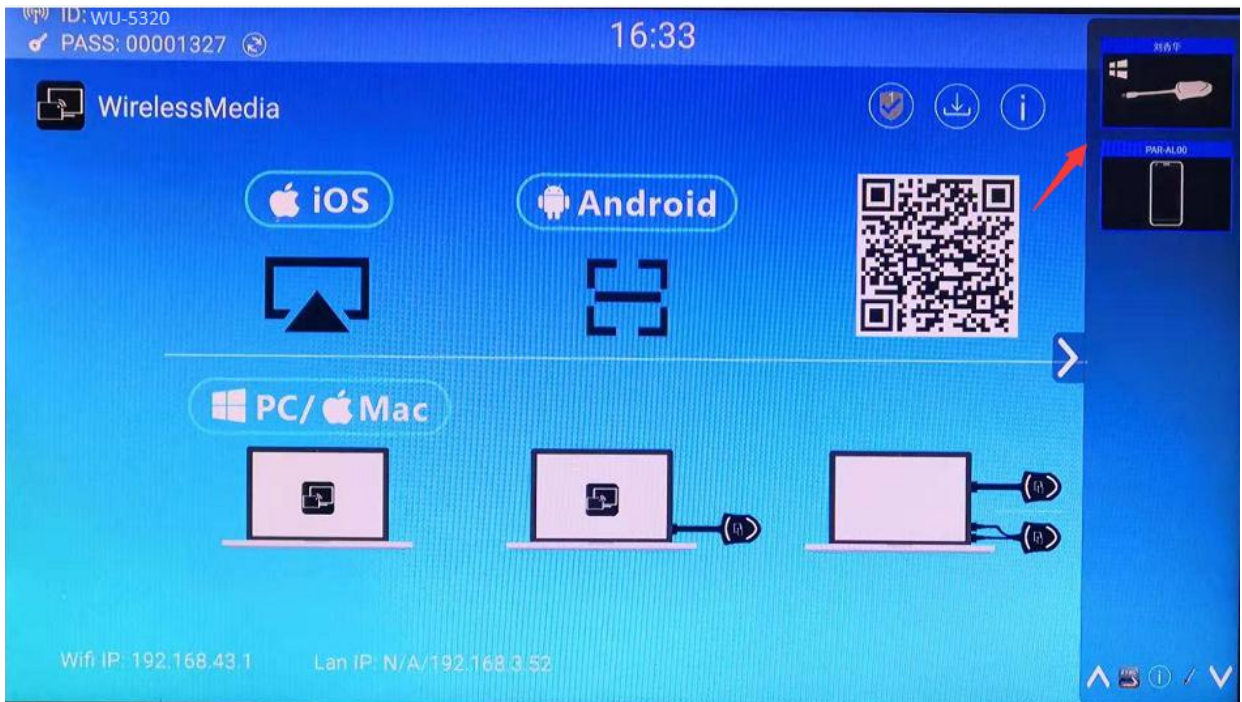

7.4 System settings

7.4.1 Buttons:

Show Device name, MAC Address, Serial Number, Device Version, Device Status, Last Action, Item Operate.

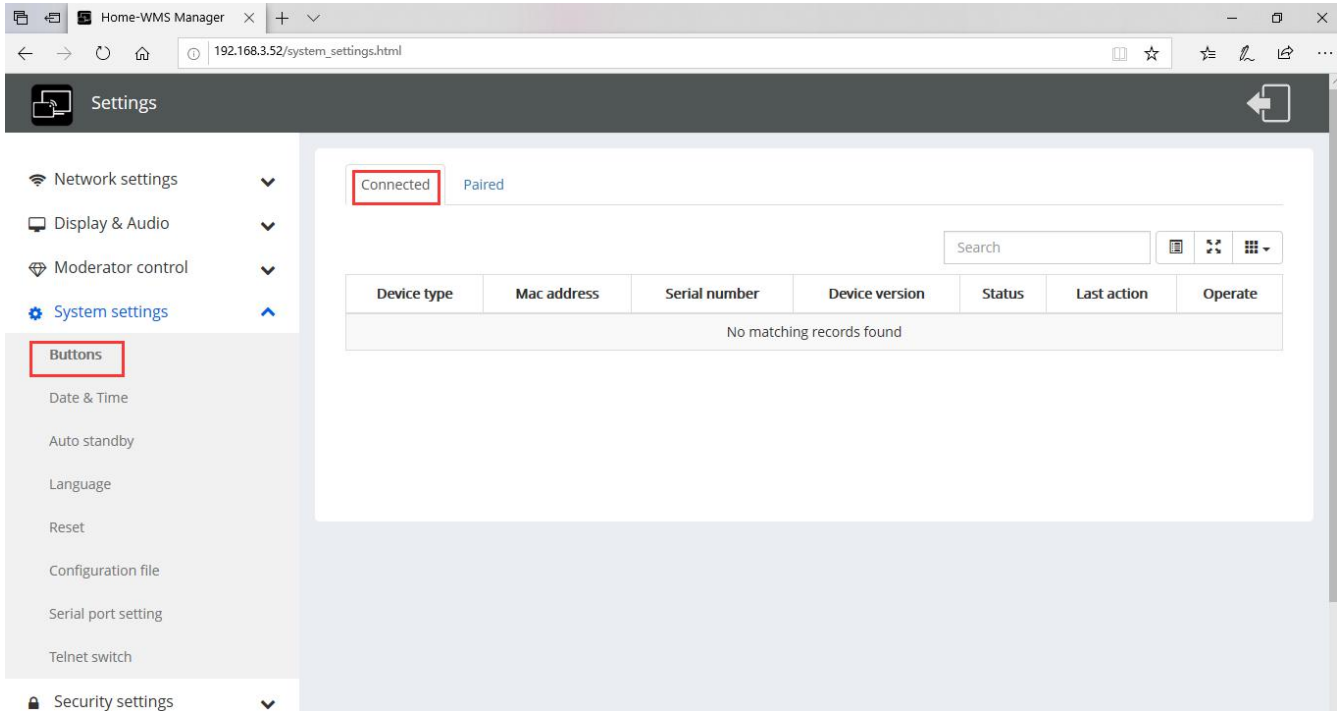

Paired: Show properties of connected dongles and can be managed from this page.

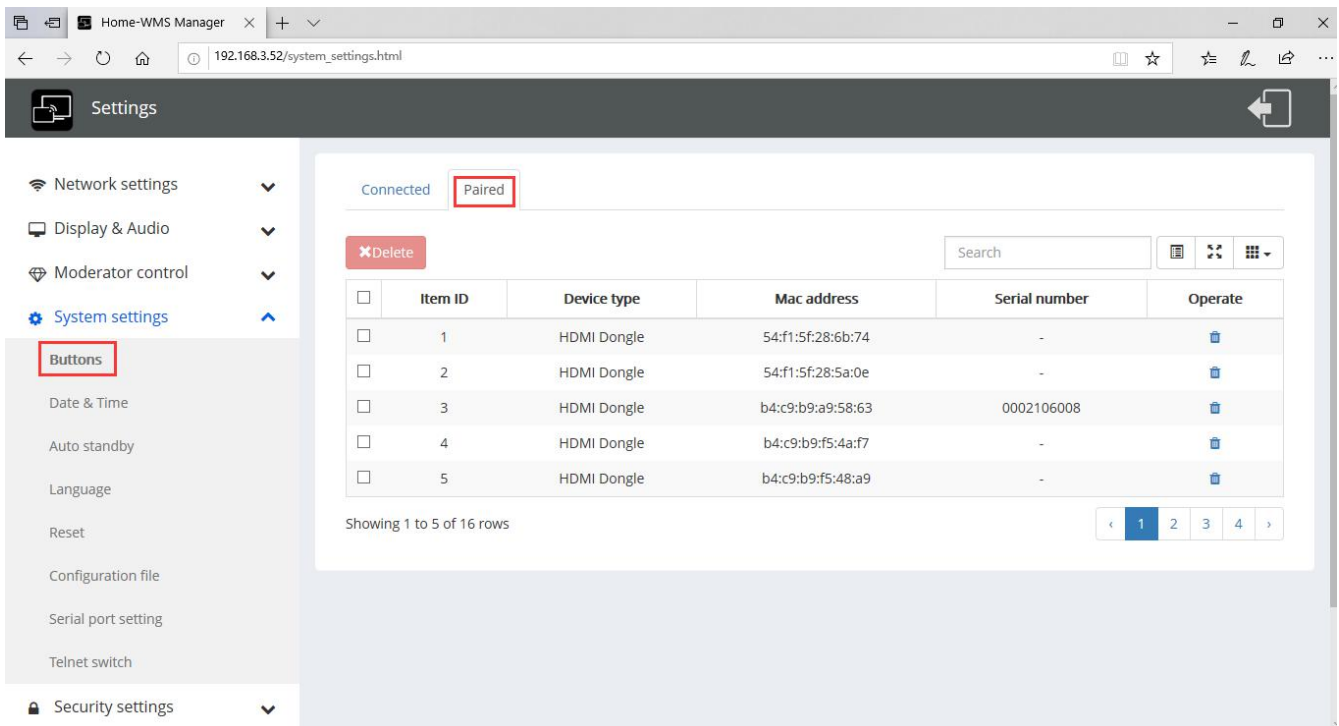

7.4.2 Date & Time

Includes Automatic date & time, Set date, Set time, Select time zone.

- **Automatic date & time:** Check to use a NTP time server to provide time as system time.
- **Set date:** Click in the input field to fill out the appropriate date.
- **Set time:** Click in the input field to fill out the appropriate time manually. The setting is **not** saved, when power is off.
- **Select time zone:** Click in the input field to fill out the appropriate time zone.

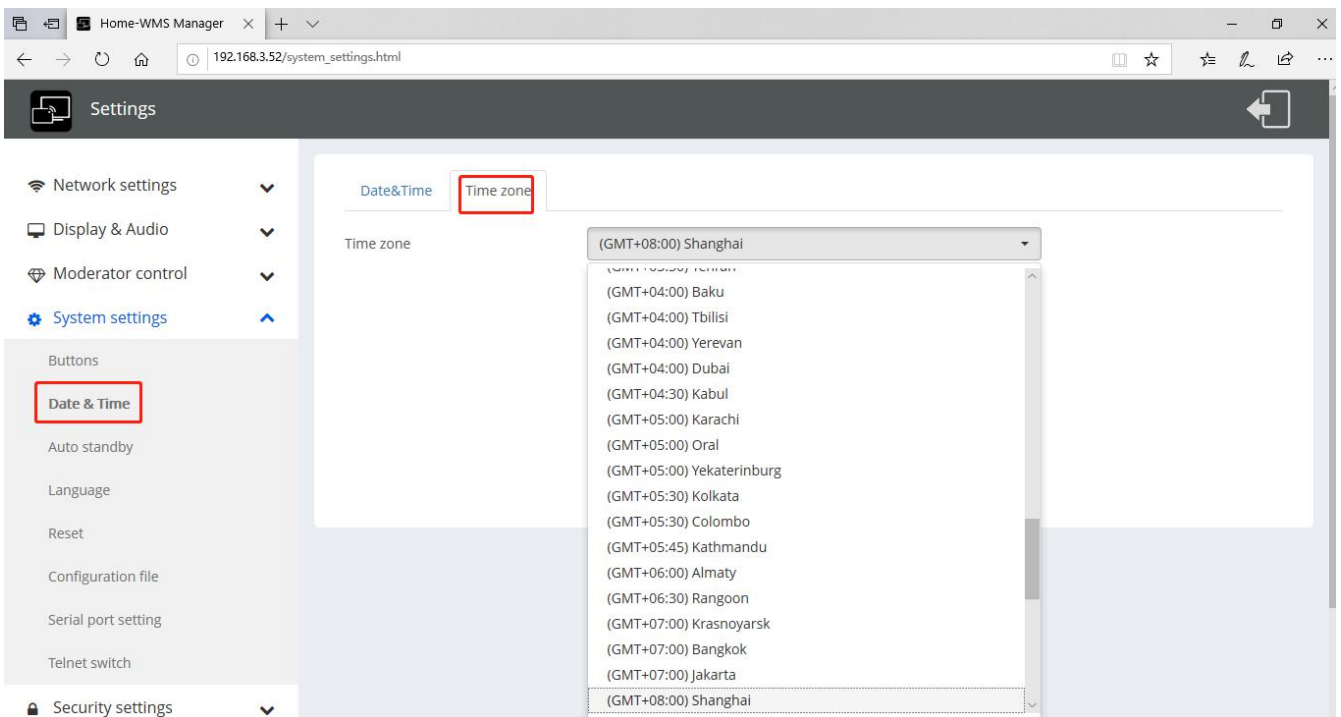
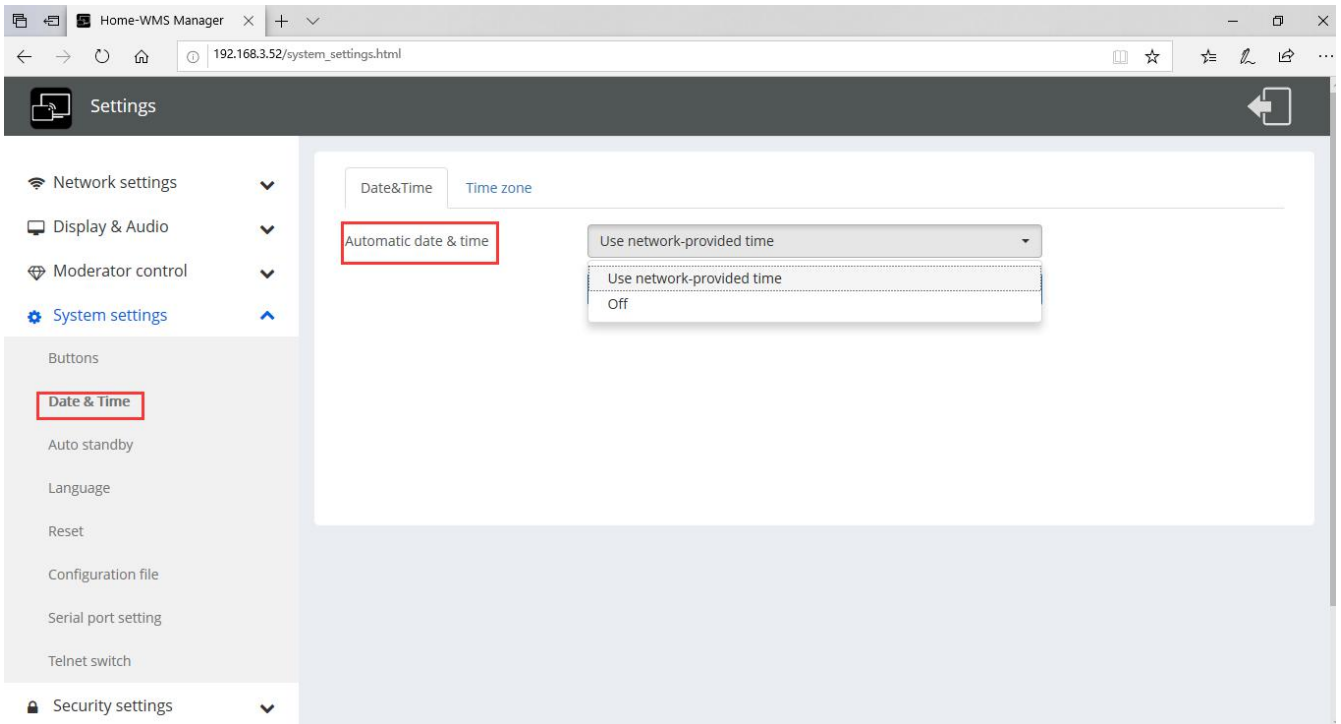

7.4.3 Auto standby

If the Auto Standby mode is activated, WirelessMedia will automatically switch to power saving mode, a selectable time after the last dongle was plugged out, or Wi-Fi of a mobile unit was disconnected, or there

is no operation at the system. Time is selectable from **Never** to **30 minutes**. In Standby green LED in top of Base-unit is flashing and **HDMI-output is switched off**.

When a **dongle is plugged in and connected**, or a **mobile unit is connected**, Standby is deactivated.

Movement of mouse at USB-input at Base-unit deactivates Standby mode also.

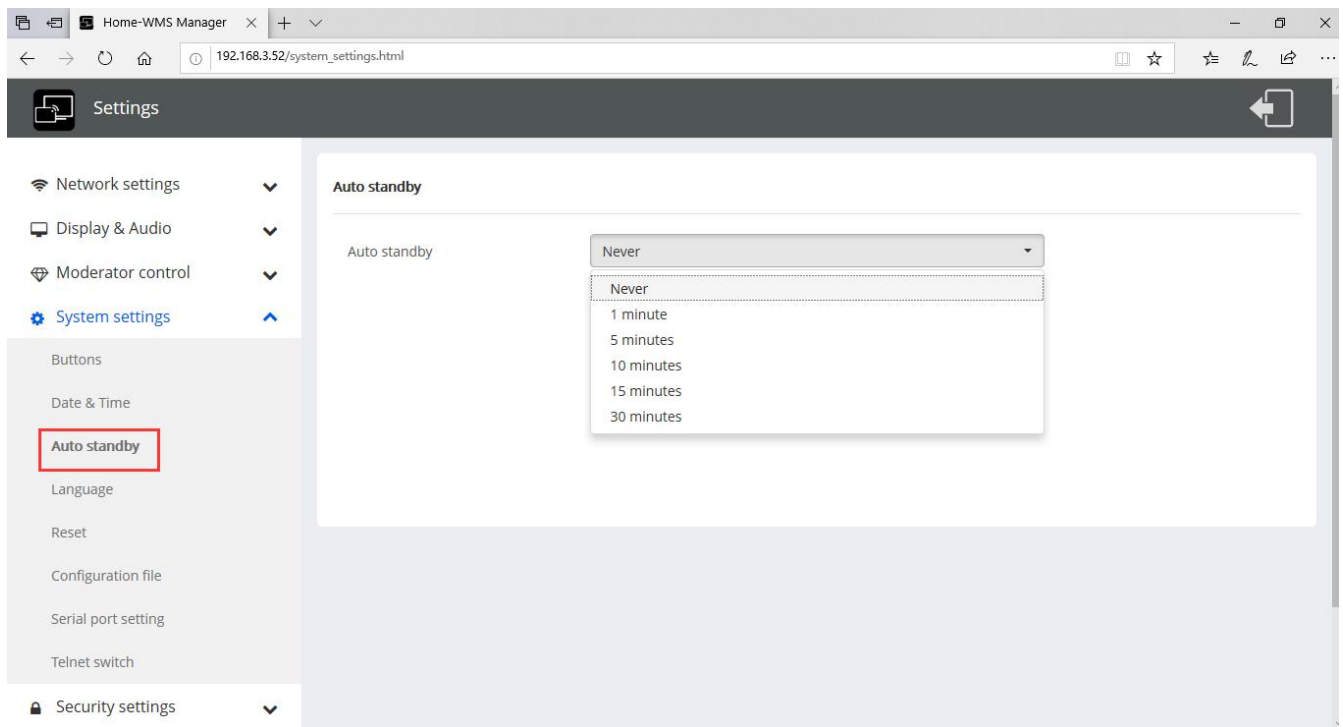

7.4.4 Language

Select an installed display language.

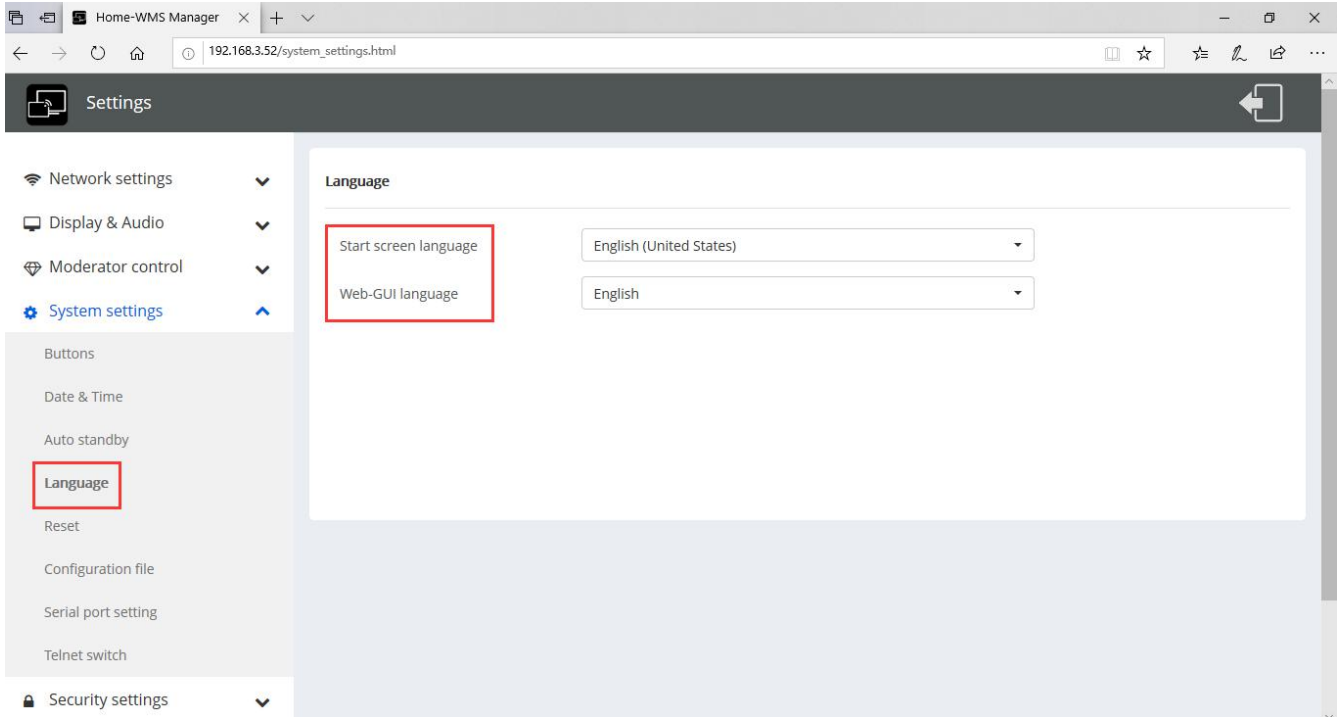

7.4.5 Reset

Doing factory reset to restore unit.

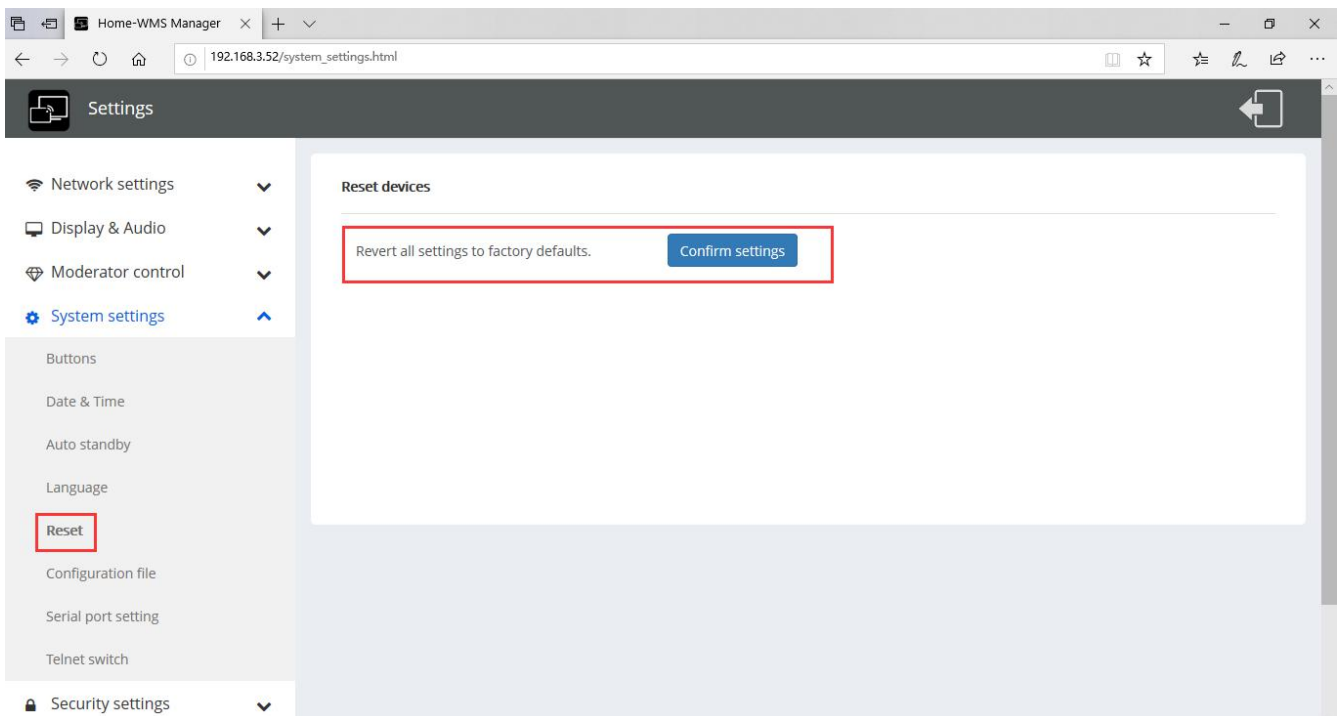

7.4.6 Configuration File

Configuration File is a packaged file which contains all the configuration parameter of the WU-10, which could be downloaded and copied to multiple device which needs to use the same configuration.

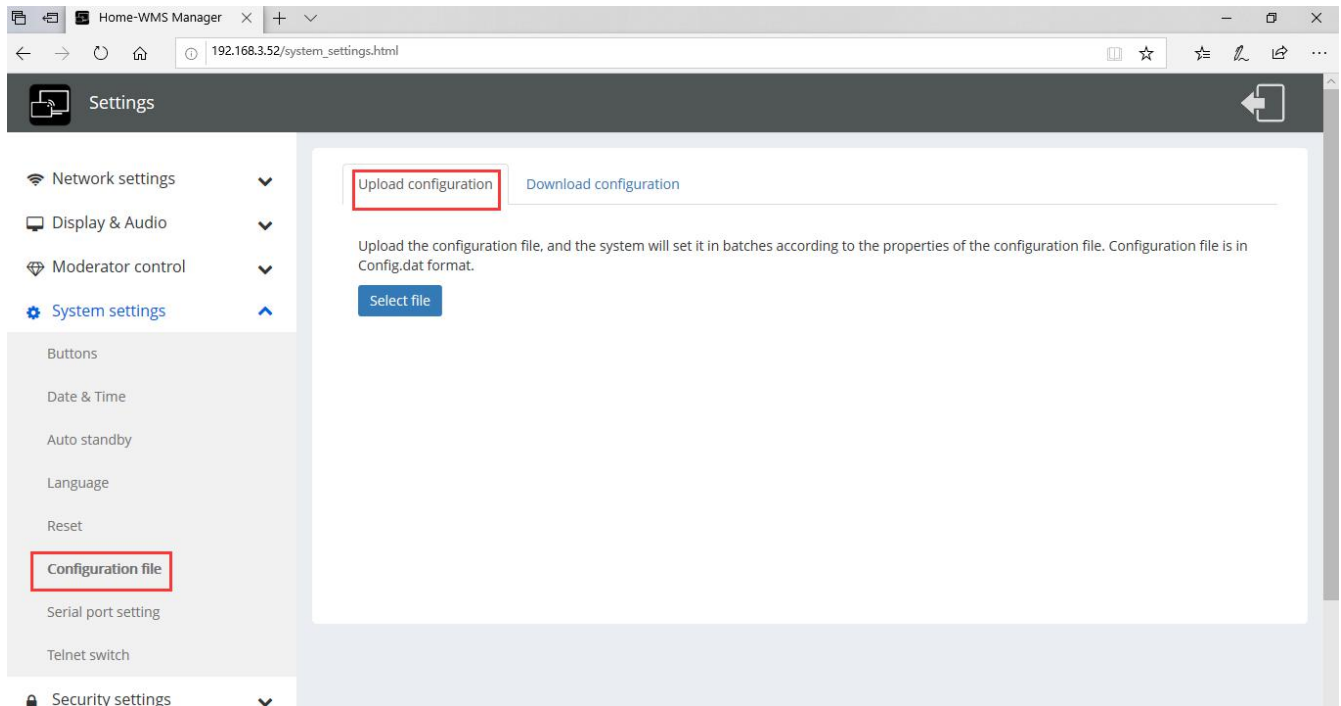

7.4.7 Series Port Setting

To configure telnet command and RS-232 command.

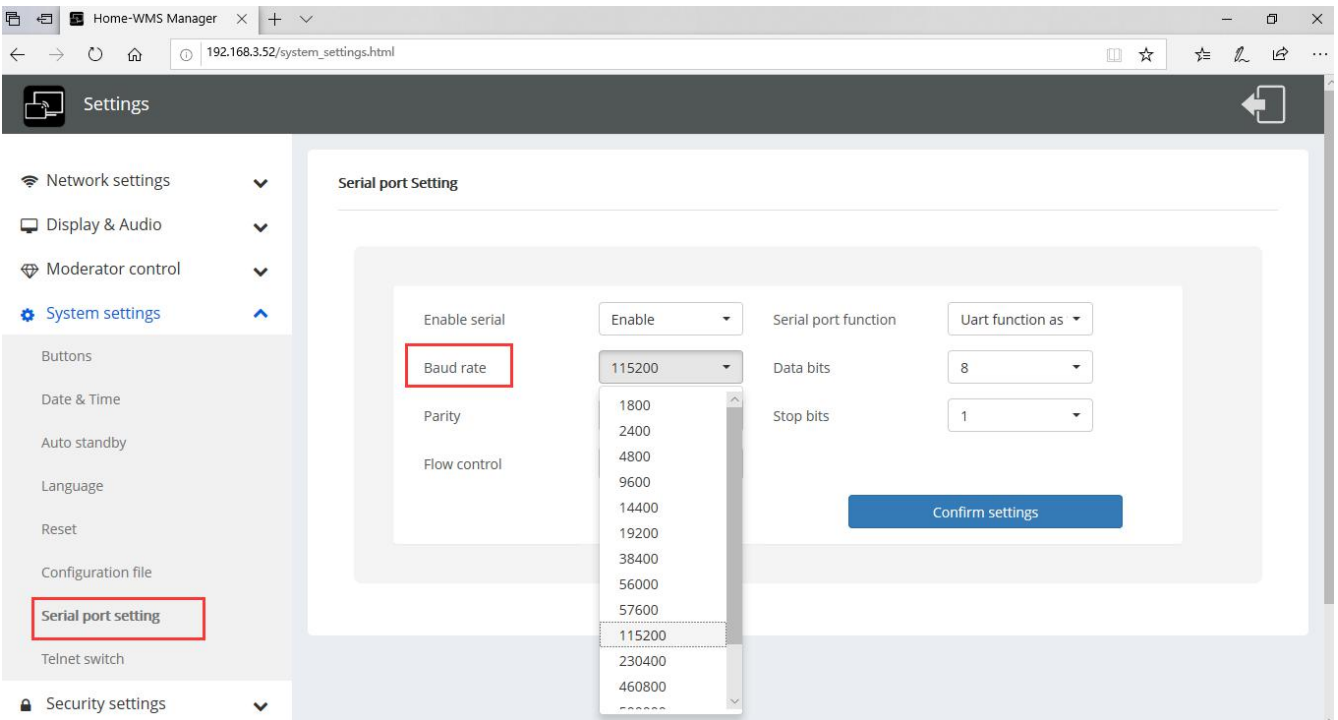
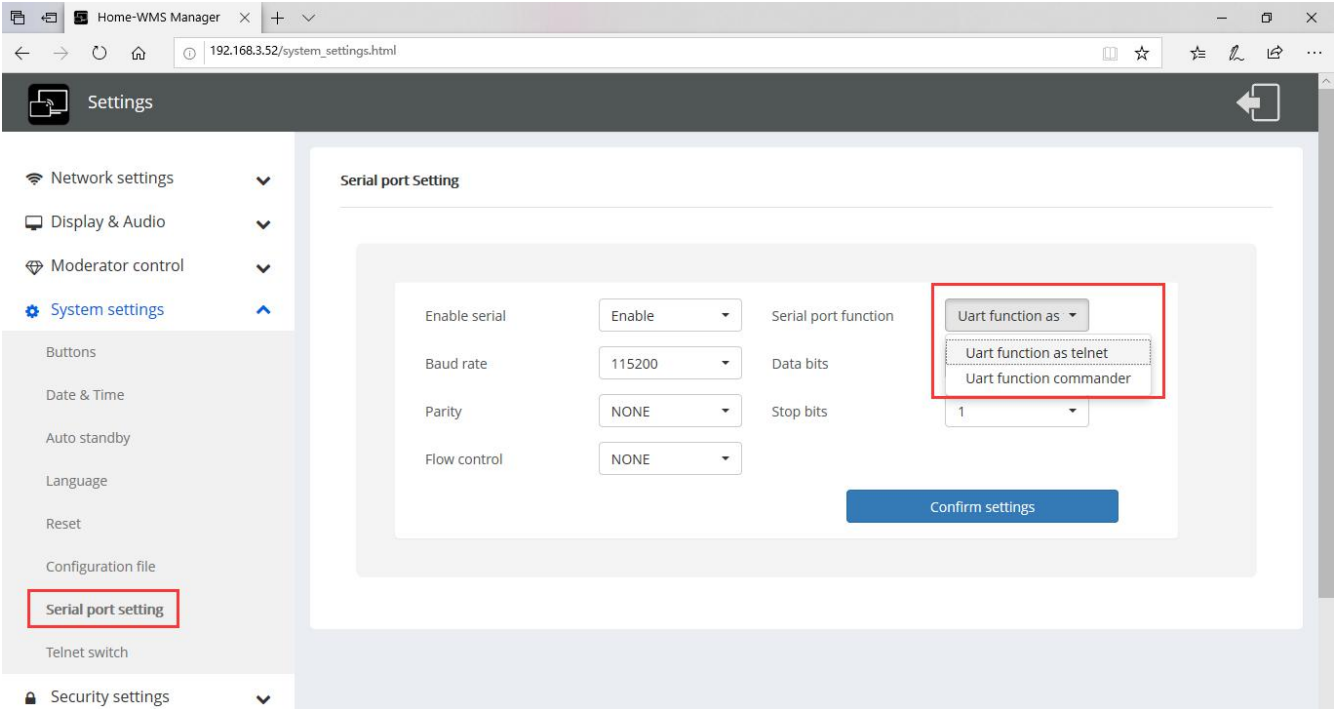

7.4.8 Telnet switch

Switch on or off the telnet function.

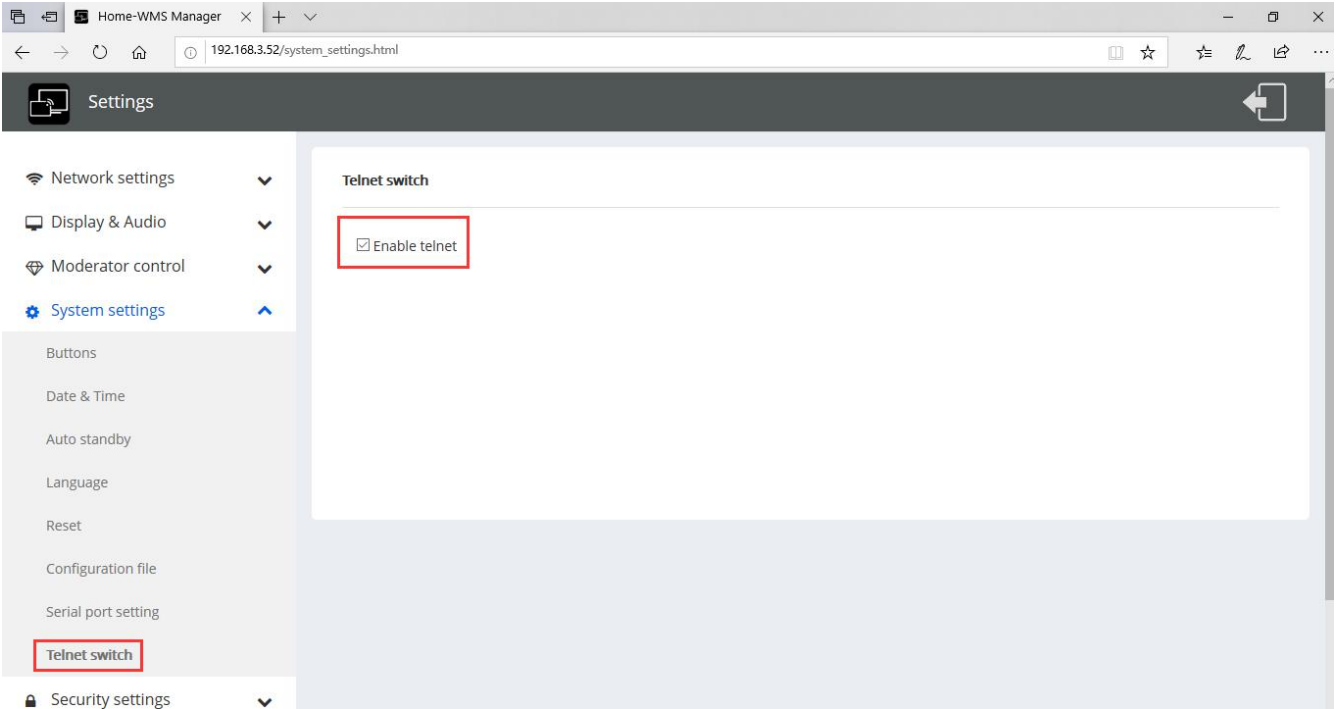

7.5 Security Settings

7.5.1 Security level

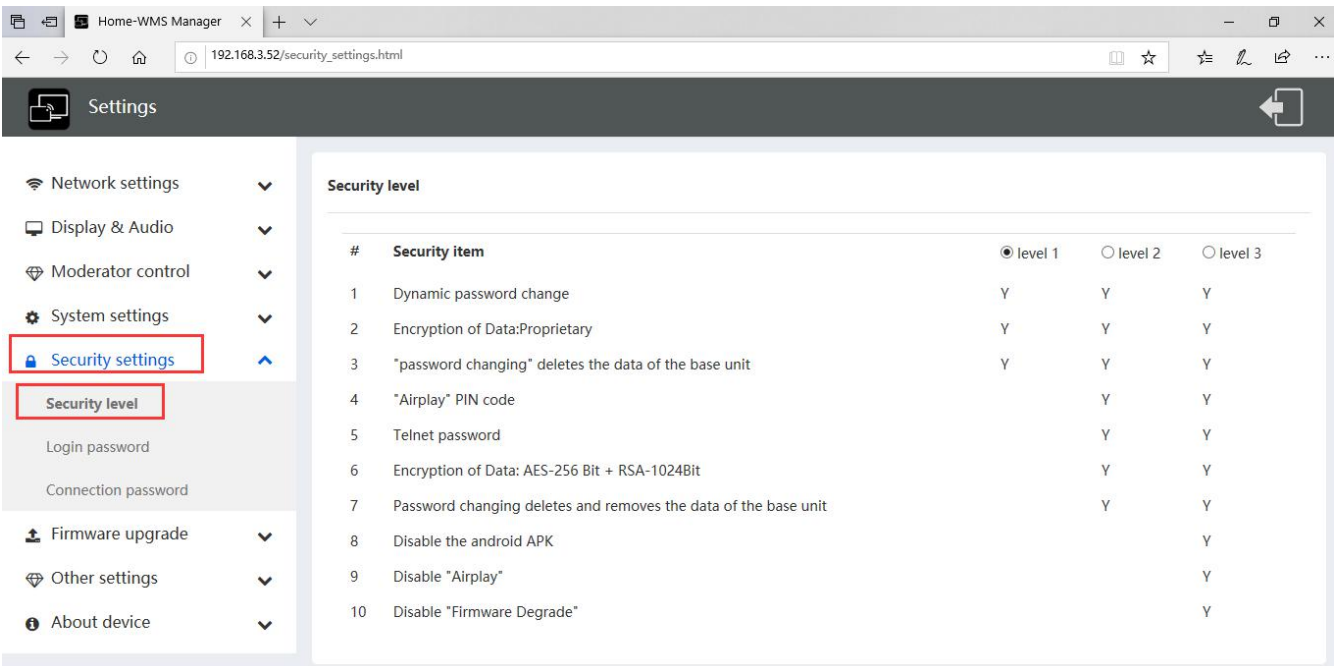

Based on user requirements, **three different security levels** can be set in the menu of WirelessMedia, to satisfy different security requirements, according to different security sensitive environments or security policies. A security level is a predefined set of settings. Click on the corresponding entry in the menu if you want to adjust

the respective security features. The default setting is level 1.

Level 1: normal safety; keeps the security in normal and daily usage for any organization, such like classroom, regular meeting room etc.

Level 2: higher security; provides increased security for companies, organizations, government agencies, etc., through powerful encryption of audio and video data; other security features include limiting the transmission of "AirPlay" by introducing a password.

Level 3: is used for strict security requirements of companies, organizations, authorities, banks.

This level contains all "Level 2" security measures; in addition, all mobile applications, such as the Android APP as well as AirPlay are blocked, the web browser (WebUI) of the Base-unit is blocked. In addition, the downgrade of the firmware is not possible.

The setting of the security level is displayed in the Home screen, click the icon  for more information.

7.5.2 Login Password

Change admin password for entering setting menu on webserver. Default password, or after a RESET, is “admin”. You can change the password as you like. You can also deactivate the password entry, set the appropriate checkmark and “Confirm settings”.

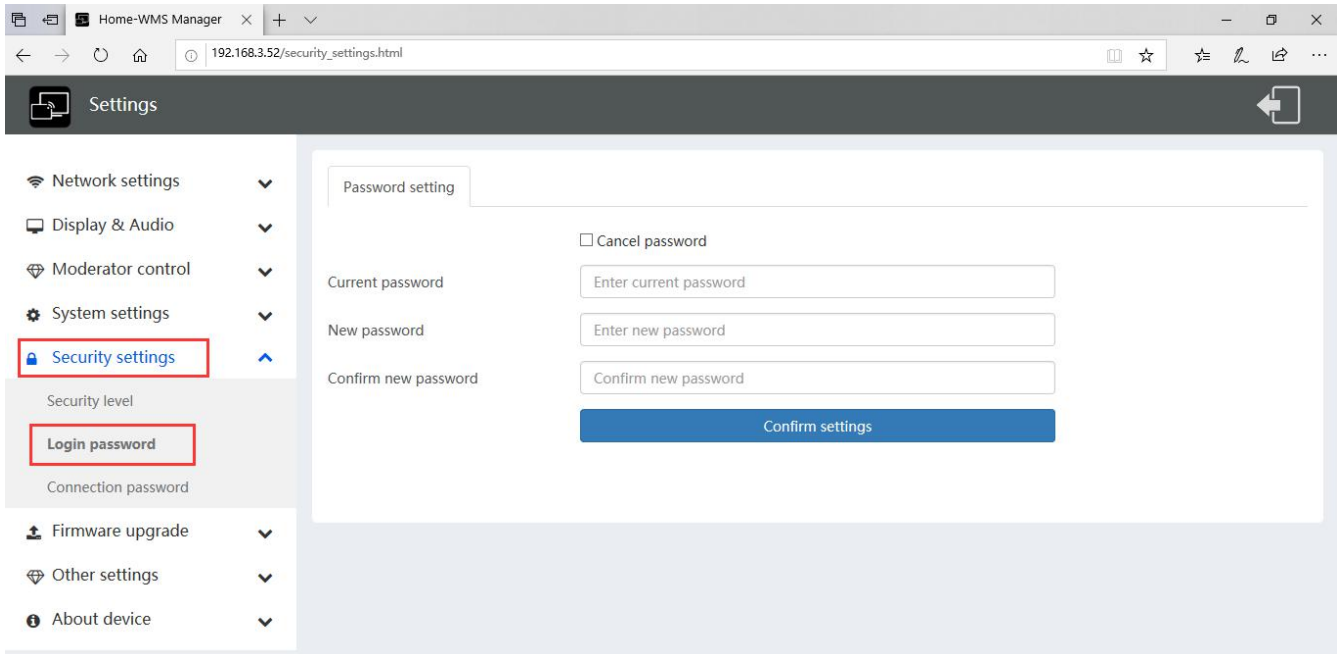

7.5.3 Connection password

Two type of password format can be chosen to show on home screen.

- 4–digits password, beginning with 0000
- 8–digits password

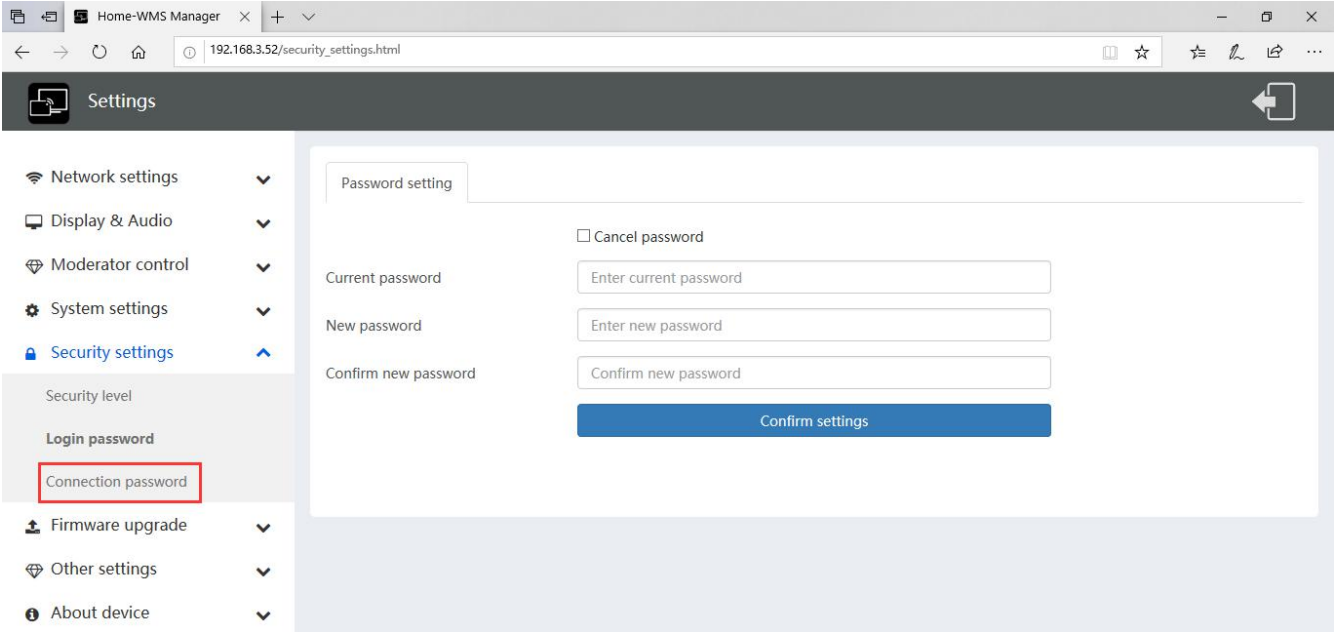

7.6 Firmware upgrade

7.6.1 Firmware Update

To upload local updating files to upgrade base unit.

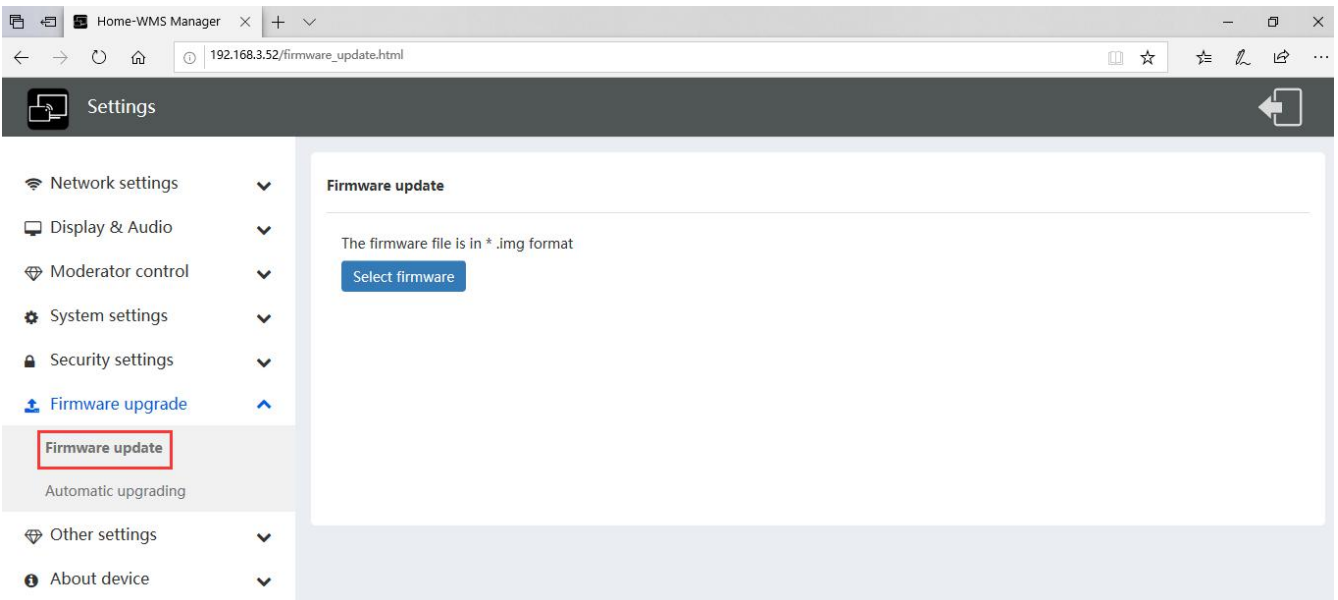

7.6.2 Automatic Upgrading

Tick to choose upgrading from OTA via Internet or from local files.

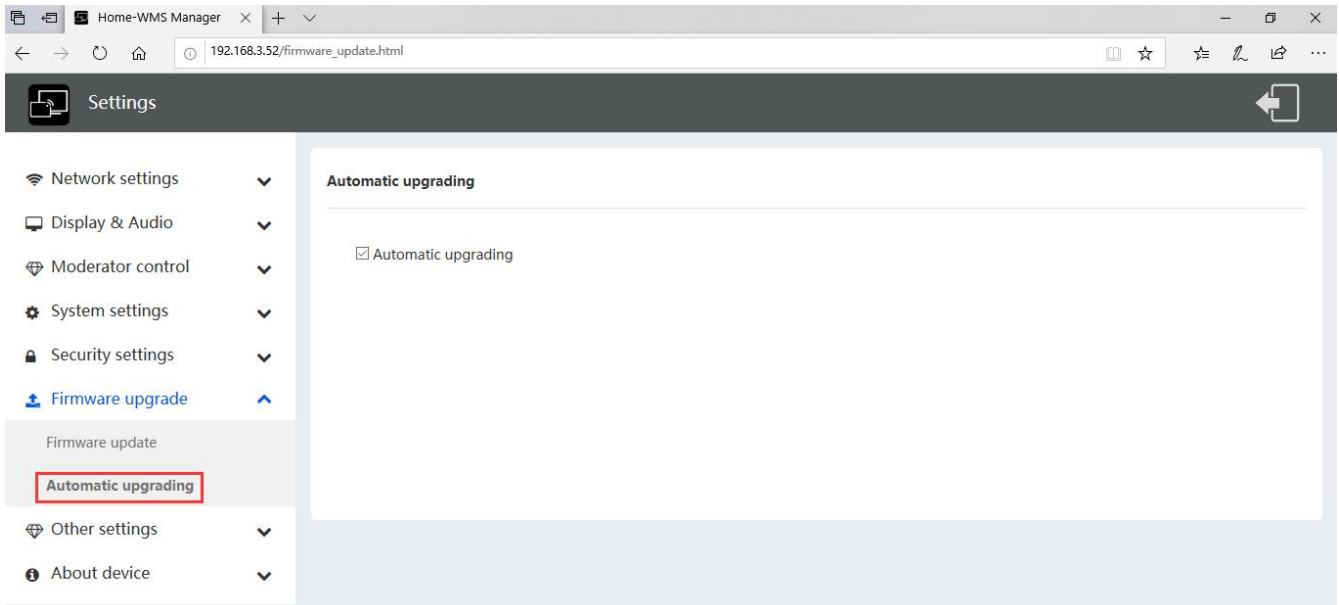

7.7 Other settings

7.7.1 Auto create launcher

Determines, when using a USB memory at one USB-port of Base-unit, the Launcher program

“WirelessMedia” will be copied automatically on USB memory. Enable or disable the corresponding box.

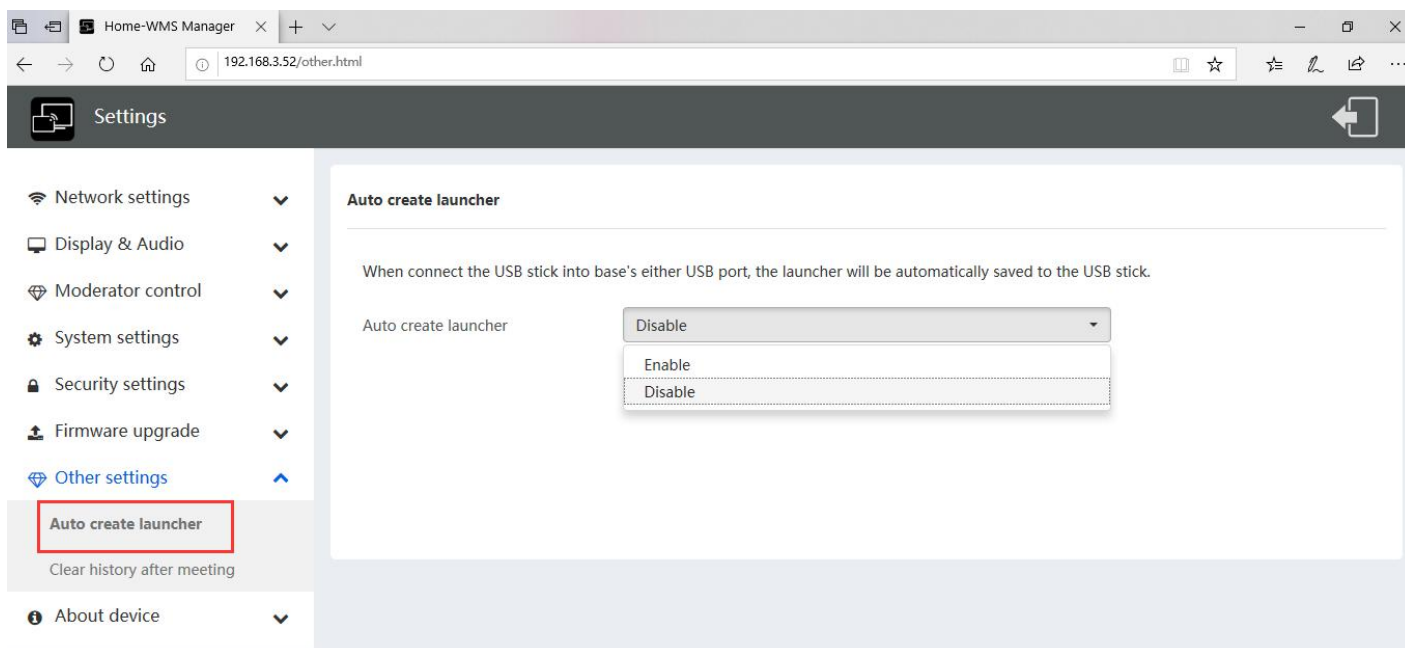

7.7.2 Clear history after meeting

Pictures, videos, music of mobile units will be stored in memory of Base-unit. This memory can optionally be erased, at the end of a meeting, when the dongle is pulled from the Laptop / PC.

Settings are:

- 🗑️ Decide by User — a dialog appears, when dongle is pulled.
- 🗑️ Never — storage space is automatically erased, when memory is filled for 90%
- 🗑️ Always — memory is automatically deleted.

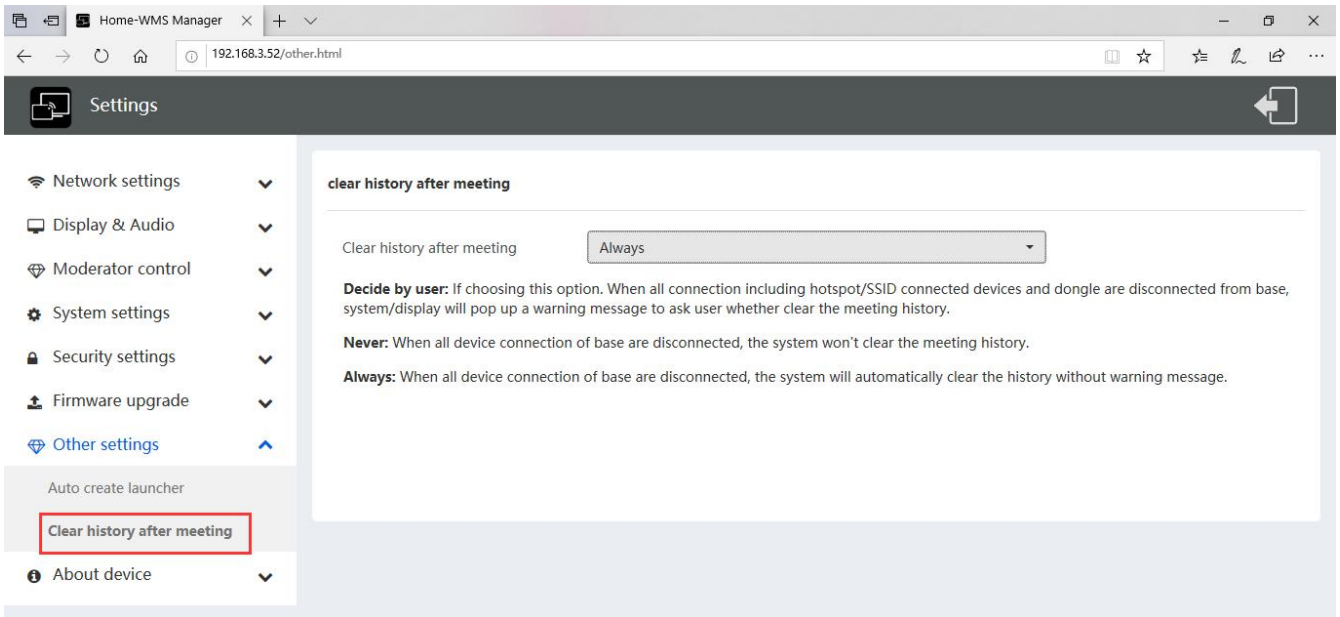

7.8 About device

Check the firmware version of base unit and web server version.

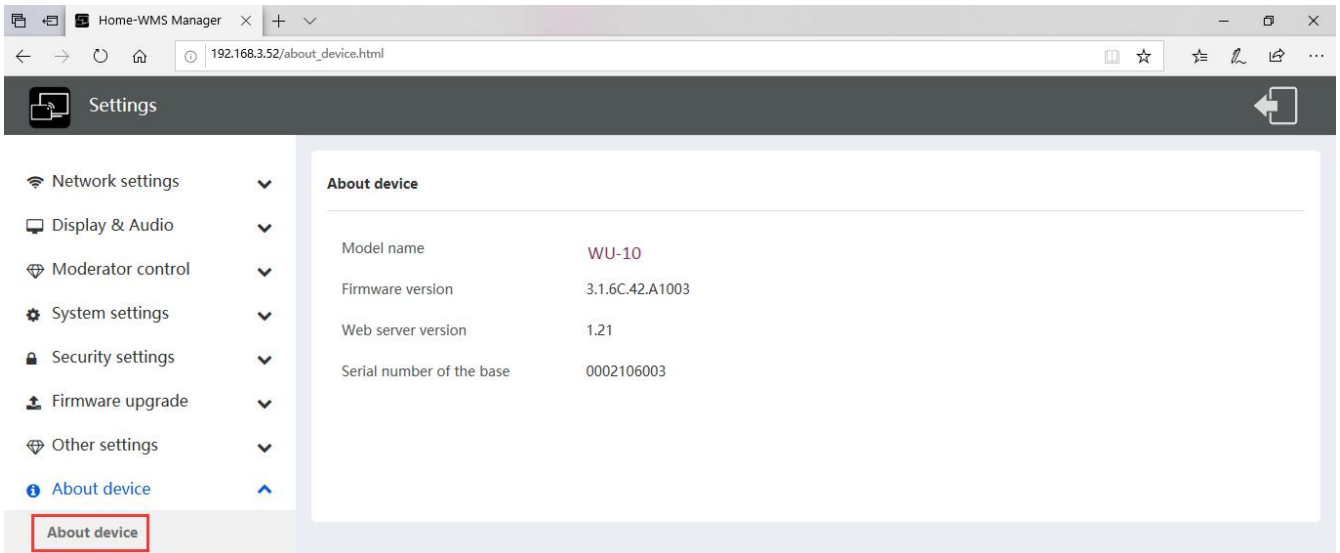

8. Updating WirelessMedia

An update of the firmware can be useful to take the advantage of new features of WirelessMedia or to fix known issues and bugs. WirelessMedia includes two methods of updating. Updating by USB stick and webserver.

After updating the Base-unit, always check, whether the other parts still fit together or should be updated also.

There are **up to three different areas** for updating: Firmware **Base-unit**, Firmware **dongle** and **Launcher** for PC/Laptop or MAC “WirelessMedia.exe“. All software is stored in Base-unit, to be transferred manually to different devices.

8.1 Check current firmware information

Base-unit: webserver “console” menu / About device.

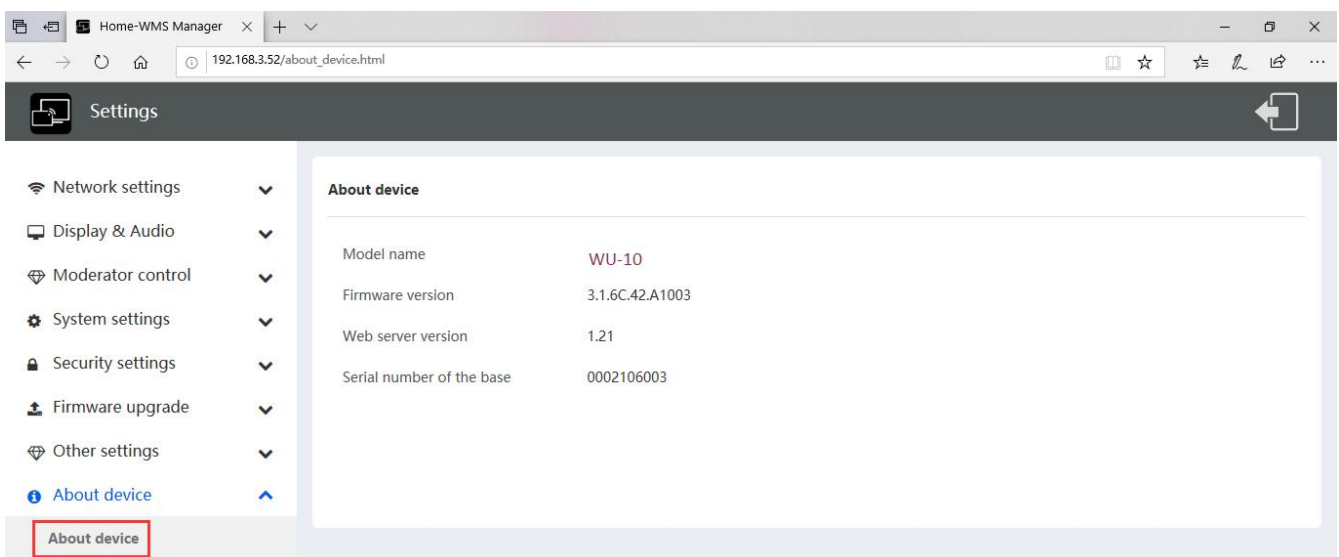

Windows OS:

Dongle/Launcher: firmware version can be visual in the “WirelessMedia”.exe” program icon in windows status bar by right-clicking the “WirelessMedia” icon and select “About”, as shown below.



Click “About” to check dongle and launcher program version.

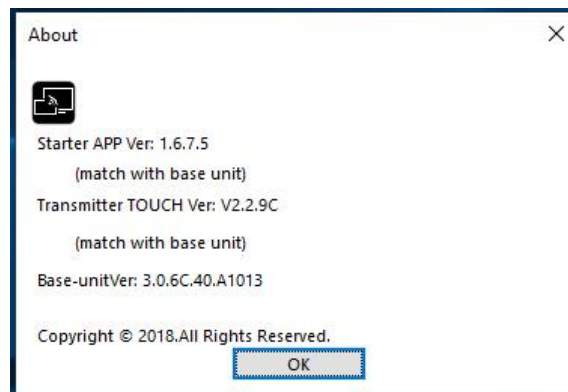

MAC OSX:

Dongle/Launcher: firmware version can be visual in the “WirelessMedia”.app” program icon in MAC OSX status bar, by clicking the “WirelessMedia” icon and select “About”, as shown

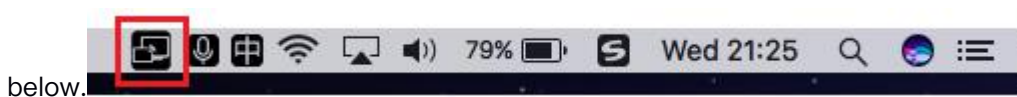

below.



Click “About” to check dongle and launcher program.



Firmwares are NOT matching:

When dongle firmware or “Launcher” firmware are older version, or in other words dongle firmware or

“Launcher” firmware doesn’t match with the base unit version, it shows up ““WirelessMedia” ATTENTION”

alert message box in the window OS or MAC OSX, as below.

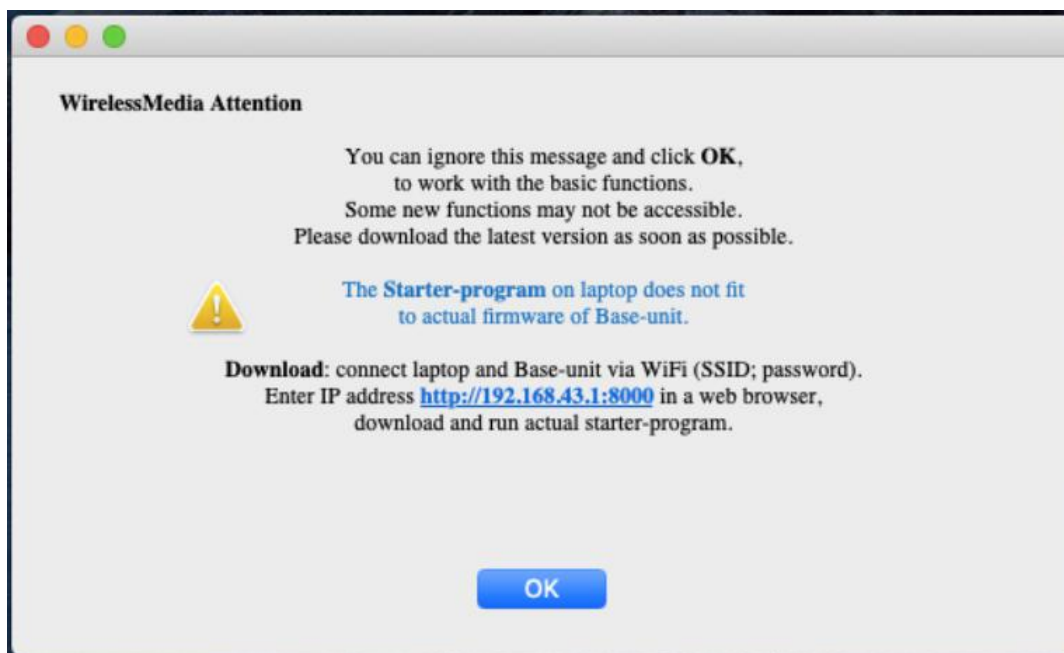
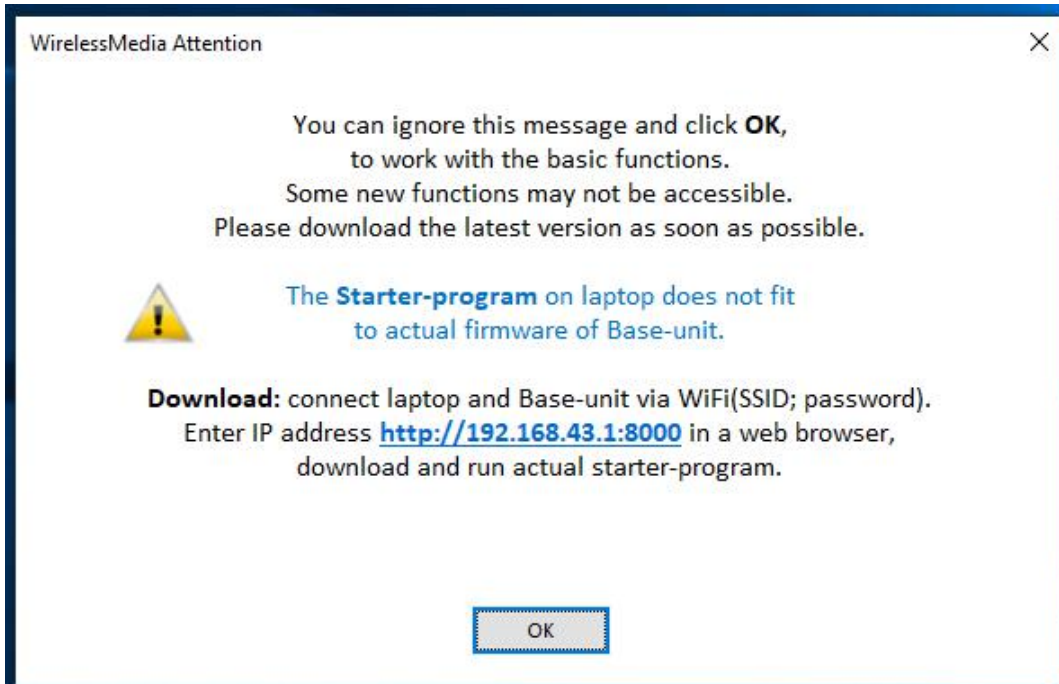

When mismatching occurs, please do the following steps to update the firmwares, as indicates in the message box.

8.2 Upgrading firmware of base unit:

There are two ways to upgrade base unit as below.

First method to upgrade base unit as below:

The base unit device can be updated through a USB drive as below.

1. Copy the updating file “update.img” to the root directory of the USB drive.



2. Connect the USB drive to either USB port of **Base-unit**.

Note: The USB port can only support maximum 500ma. Please use a small power U-disk as upgrading USB drive.

WirelessMedia recognizes the “**update.img**”-file at a plugged-in USB stick automatically and starts the “Full Update” procedure.

You can plug out the USB stick within 10 seconds to stop the update.

Attention !

Do not disconnect power during upgrading progress. Or, the unit firmware will be corrupted.

3. The upgrading progress displays as shown below, and the unit will reboot automatically after complete the updating 100%, as shown below.

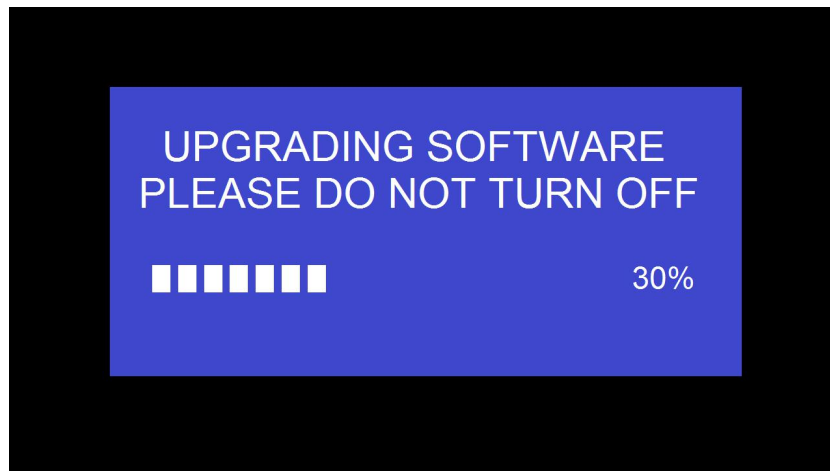

Note: During the update, screen can be temporary dark.

If the progress bar stops at 1%, use another USB stick, it may be defective.

The display device shows the Home Screen after normal boot of the device, you can disconnect USB-drive.

4. Perform “Factory Reset” when the firmware update is complete?

Only when the associated “Release notes” are requiring an additional „**Factory Reset**“, perform it via the menu “**System settings**” / “**Reset**” on webserver console menu.

All data of configuration will be lost. So that you do not have to re-configure all data in an elaborate process, therefore note all settings within the Sub-menus before doing Factory Reset.

5. The update of Base-unit is finished.

Second method to upgrade base unit as below:

Base unit can be upgrade via webserver console menu as below:

Select a “update.img” file to upgrade to target version.

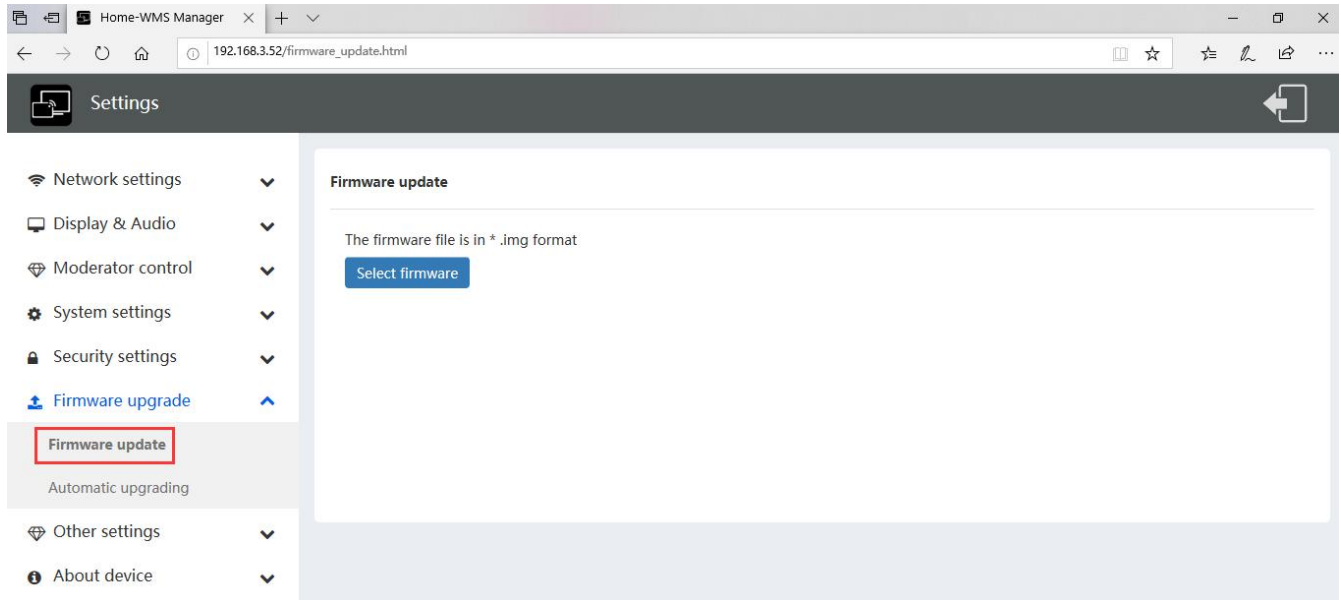

8.3 Upgrading and Pairing of Dongle:

1. Plug the dongle to either of the two USB port of WU-10 to be updated. It will automatically show up a message to indicate if the installed firmware of dongle is older, and needs to be upgraded.

Note: Type C dongle needs to plug into Type-C port of front base unit to upgrade.

The upgrading progress starts automatically with the progress bar, as shown below.

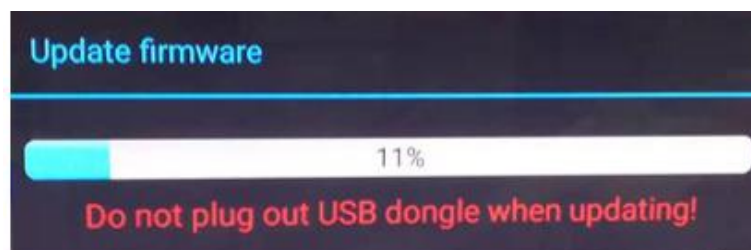

2. “Pairing” to the Base-unit is done automatically afterwards, it shows as below



3. Plug out the dongle. Now, the upgrading progress is finished. Update all other dongles accordingly.

8.4 Upgrading Launcher:

Attention: The USB driver should be FAT 32 format not NTSC format.

After upgrading **Base unit** and **Dongle**, the launcher should be written with the actual launcher program for Windows, MAC and Apps for mobile-units.

There are 2 methods to update the USB stick/launcher, including:

Method 1: Via USB stick

1. Connect the USB drive to either USB port of base unit.
2. Click the "Download" icon  in "Home Page", pls see as below:



3. The Launcher “WirelessMedia” is written to the USB–stick, an OSD–windows shows the progress. When ready, unplug the USB–stick.

Method 2: Via WIFI

1. Connect PC to WU–10’s SSID and enter password in homepage, see pictures as below:



2. Open Browser and enter WiFi IP: 192.168.43.1

3. Click to enter “Launcher” download webpage. Shown as below:

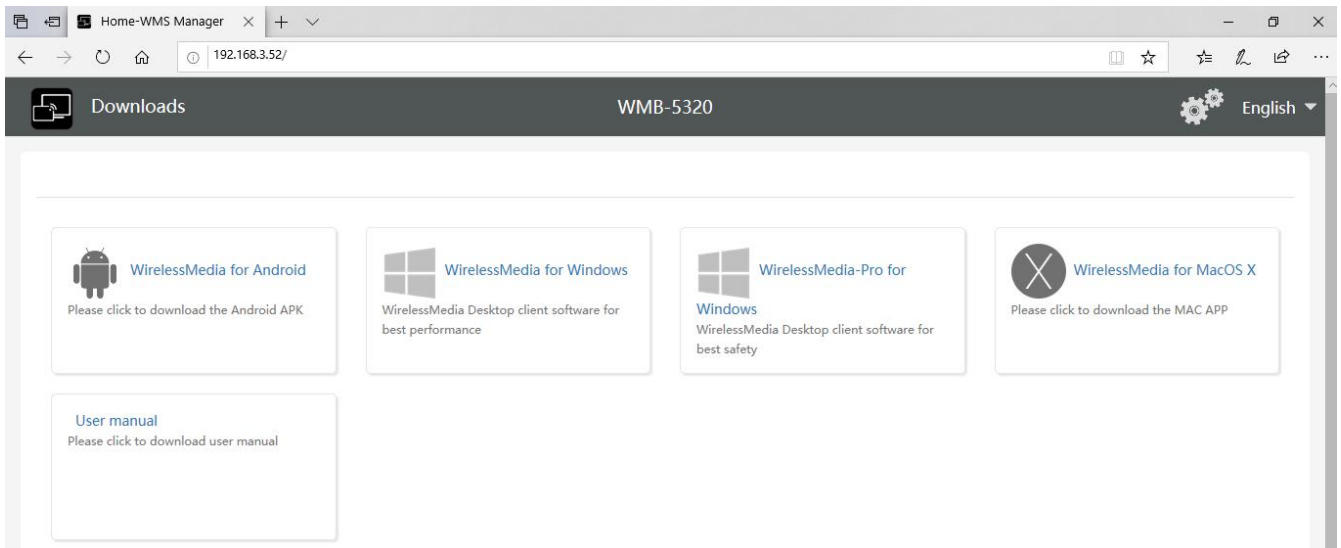

4. Choose and click Windows or MAC launcher to download.

5. Find the “Launcher” program in PC and copy to PC desktop. (Recommend to copy to desktop for quick run.)

6. Run the program to start sharing.

Two methods to execute the launcher for first time user

- Copy the program to PC, and click to execute it to share PC screen.
- Connect dongle to PC; click to run program from the USB drive and share PC screen.

For both two methods, user don't need repeat the above steps since the second time plug-in.

The Launcher program "**WirelessMedia for Windows**" and "**WirelessMedia Pro for Windows**" includes by default an additional virtual driver "ExtendedDesktop" to optionally install the Windows 10 Extended Desktop functionality, if they are is needed. This may require admin rights.

8.5 Clean left files of older versions of Launcher program in Lap-top

There are some old version “WirelessMedia” files left in the lap-top, which may influence the performance of the newer “WirelessMedia” program. Currently, it needs to manually clear them, before start to use the newly updated “WirelessMedia” firmwares.

Steps:

1. Find the place where the left “WirelessMedia” programs are stored. Normally, these files are stored in the C:\Users***(user name)\AppData\Local\”WirelessMedia”, as shown below.

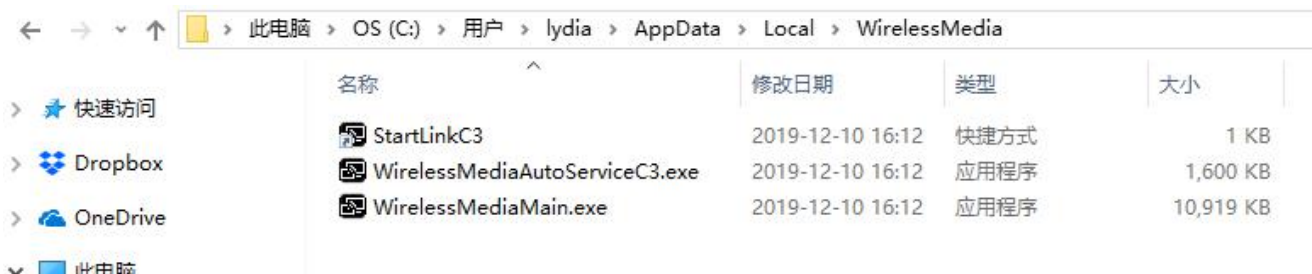

2. If the “*.service” “*.serviceC3” can’t be removed and shows up an alert message as below, please use combined hot key to open the task manager by pressing “**Ctrl+Alt+Delete**”, as shown below.

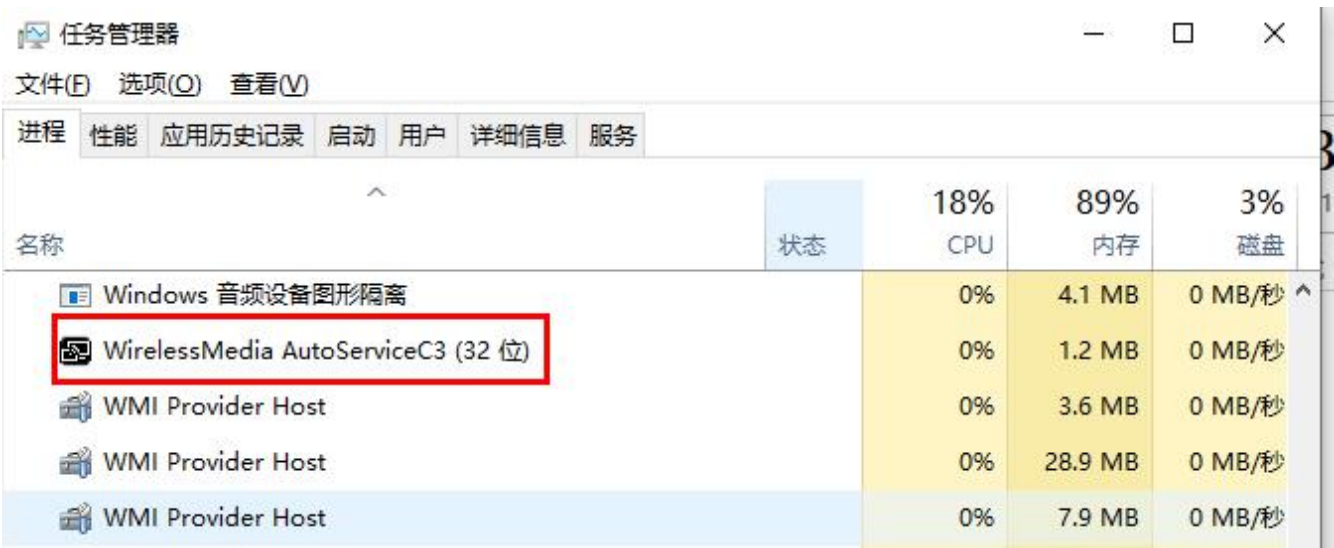
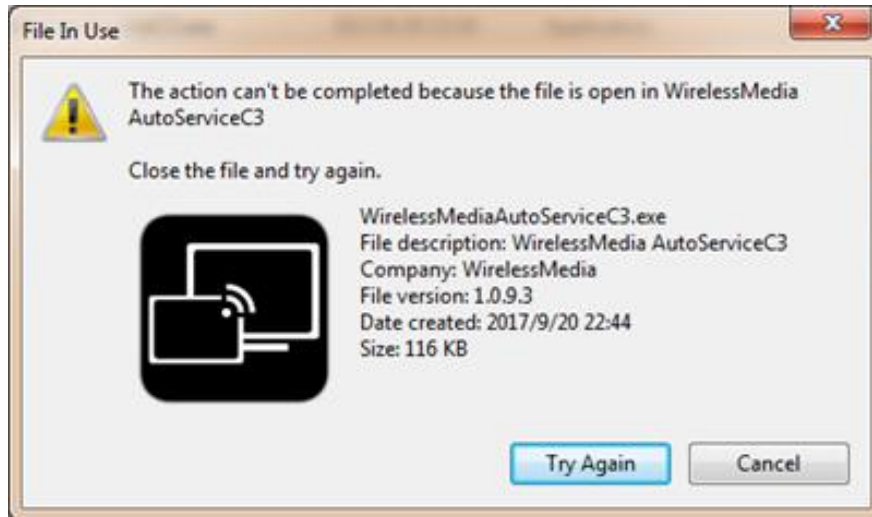

3. Right-Click on the "*.service" or "*.serviceC3", for example right-click on "WirelessMediaAutoServiceC3.exe" as shown below, and click to End Process Tree.
4. Check again the task manager, to be sure there is no more any "WirelessMedia" programs still running in the task manager. And check again to be sure there is no more any "WirelessMedia" in the C:\Users***(username)\AppData\Local\ "WirelessMedia".
5. Execute the actual version of Launcher program.

Upgrading progress is completed.

9. WIFI Recommendation Setting

9.1 Check the WIFI config on base unit

Please use a WIFI analysis software to place it at the same place as the base unit, to check the WIFI environment, in order to select the clean or unused WIFI frequency between 2.4GHz and 5Hz, and the WIFI channel as below.

2.4GHz: 1, 2, 3, 4, 5, 6, 7, 8, 9, 10, 11

5GHz: 36, 40,44, 48,149, 153, 157, 161

9.2 Check the WIFI RSSI on dongle or Mobiles

Please use a WIFI analysis software to place it at the same place as the dongle or mobiles, to measure the WIFI RSSI (Received Signal Strength Indicator). We recommend the RSSI shall be above -70dB to be good enough to keep a stable signal transmission. If not, please try to take the following measures, as in the problem shooting---*Bad wireless connection* congestion.

10. Problem Shooting

Here you can find some fundamental problems and possible causes, which can be happen during the use of “WirelessMedia”. Find out the problem you’ve encountered in the table below and apply the solution.

Problem	Cause	Solution
<p>Use “WirelessMedia for Android” application in Android device or Airplay on IOS device, and it can’t find base unit device.</p>	<p>WIFI password of base unit changed when android or IOS device is connected to the WIFI of base unit.</p>	<p>Reconnect the mobile by entering password showed on home screen.</p>
<p>The image quality on the main display screen is not good.</p>	<p>The quality or length of the cable between the Base Unit and the display or the connection between these two.</p>	<ul style="list-style-type: none"> ● Replace the cable ● Use another cable. ● Check the cable to be fasten properly.
	<p>Improper resolution for the main screen.</p> <p>WMB1 could output</p> <p>3840x2160_60Hz,</p> <p>3840x2160_50Hz</p> <p>3840x2160_30Hz,</p> <p>1920x1080_60Hz,</p> <p>1920x1080_50Hz,</p> <p>1920x1080_30Hz</p>	<ul style="list-style-type: none"> ● Change the resolution on the Setting configuration. And match it to the native resolution of the main screen. See chapter 7.
<p>Bad wireless connection. The connection between the transmitter and the base unit is not stable.</p>	<p>Wi-Fi problems.</p> <ul style="list-style-type: none"> ● Interference in the radio channel. ● Overload in the radio 	<ul style="list-style-type: none"> ● Use a Wi-Fi scanner to find a free wireless frequency and channel and select it via the setting configuration.

	<p>channel.</p> <p>“WirelessMedia” does not automatically jump to other channels when there are changes in the RF environment.</p>	<ul style="list-style-type: none"> ● Regularly check the RF environment if there are frequently changes in Wi-Fi networks in your environment.
	<p>Low signal strength:</p> <ul style="list-style-type: none"> ● Metal cabinets, walls, construction elements, ...can cause reflections deteriorating the wireless signal. ● Obstacles between dongles and Base unit cause lowering of the wireless strength and quality. 	<ul style="list-style-type: none"> ● Put the base unit closer to the main screen. ● Change the orientation of the antennas at the rear panel of base unit to the transmitter direction. ● Remove or limit as much as possible all obstructions between the transmitters and base unit. ● Avoid to place the Base-unit in (metal) cabinets, suspended ceilings, under tables or in adjoining rooms.
<p>Can't get the “WirelessMedia” run when plug the transmitter to</p>	<ul style="list-style-type: none"> ● When you are using “WirelessMedia” for the first 	<p>There are 2 possibilities to load the</p>

<p>lap-top</p>	<p>time on your laptop or for guests, you have to copy the Launcher program</p> <p>“WirelessMedia windows. Exe” or “WirelessMedia macOS. app” for first on your Laptop /PC. Run this Starter-program. You can run the Starter App without Admin-rights.</p>	<p>Launcher program, see chapter 7.4.</p> <p>Best is: download the App via LAN or Wi-Fi of Base-unit. When the Launcher program is preinstalled one time, “WirelessMedia” is ready to use later immediately.</p>
	<ul style="list-style-type: none"> ● Bad connection at USB port on the lap-top 	<ul style="list-style-type: none"> ● Reconnect to the USB port ● Try another USB port ● Reboot the lap-top
	<ul style="list-style-type: none"> ● Some types of USB devices might be blocked as the company policy. ● USB port setting on the lap-top might limit the usage of high power USB device when on battery power. 	<p>If possible, change the USB port policy on the lap-top</p>
<p>Low video performance (sharpness, audio and video</p>	<ul style="list-style-type: none"> ● The media-player is not ideal. 	<ul style="list-style-type: none"> ● Use another media-player (VLC player...), another

<p>dropouts, video stream is jerking, ...)</p>	<ul style="list-style-type: none"> ● The video quality also depends on the computing power of the PC / laptop and the interaction and CPU load with other running software applications. ● A laptop in battery mode can be switched to reduced computer power, to save energy. The transmission of HD video requires a certain amount of CPU power to guarantee the optimum quality of the transmission. 	<p>browser.</p> <ul style="list-style-type: none"> ● Update the software of your Video-player to the latest version. ● Reduce the CPU usage of other software applications. ● Lower the screen resolution of the Laptop. ● Update driver of graphic-card. ● End low power mode at laptop.
<p>Video is not shown on screen</p>	<p>The content use HDCP</p>	<ul style="list-style-type: none"> ● WirelessMedia input can't support showing HDCP source. If possible, connect the source device to local HDMI input at base unit.
	<p>The display cable (HDMI) is not correctly connected.</p>	<ul style="list-style-type: none"> ● Insert the display cable to the display and the Base-unit.
	<p>The displays is switched off.</p>	<ul style="list-style-type: none"> ● Switch on the display.

	<p>The Base-unit is in standby mode,</p> <p>“Power-LED” is flashing at Base unit.</p> <p>Power-supply is missed.</p>	<ul style="list-style-type: none"> ● Power off and on again or insert a dongle into laptop.
<p>When using window 7 the following message about the Window Aero color scheme appears “Windows has detected your computer’s performance is slow. This could because these are not enough resources to run the windows Aero color scheme. To improve... ”</p>	<p>WirelessMedia uses resource from the GPU. In combination with other programs which do so, Window 7 sometimes shows this message suggesting to disable Aero to improve the performance of lap-top.</p>	<ul style="list-style-type: none"> ● It’s safe to ignore this message and choose “Keep the current color scheme.”
<p>Your content is removed from the display and the LEDs on the button are blinking</p>	<p>Connection to the Base Unit is lost.</p>	<p>WirelessMedia tries to restore the connection automatically. If it fails, the LEDs on the button start blinking red.</p> <p>Unplug the button from your lap-top and try a new button.</p>
<p>Nothing is shown on the displays at all</p>	<p>The displays are switched off.</p>	<p>Switch on the display</p>

	The display cable is not correctly connected	Insect the display cable to the display and the Base Unit
	The Base Unit is in standby mode	Briefly push the standby button on the Base Unit or power off and on again the Base Unit.
No LAN connection with the Base Unit	Wrong IP address	IP address is not within LAN range
		DHCP is not enabled.
No Wi-Fi connection between mobile device with Base Unit	Wrong Wi-Fi frequency	Check mobile device to select the correct 2.4GHz or 5GHz
	Wrong SSID and password	Enter the correct SSID
No audio when transmit local file to Base Unit	Unsupportive audio format, including Dolby MS11, DDCO DTSLBR, DTSE, DTSNeoUltra, SRS-THEATERSOUND, DTS_StudioSound3D, DTS_HD,	If possible, reformat it to the other audio format, like DD, DD+, HE-AAC, DTS DMP, WMA, DRA, COOK
There is no sound at main-display.	No connected audio device.	Make sure, the audio is turned on.
	Volume is set to OFF.	Adjust level in menu configuration WirelessMedia console in on webserver settings.
	The volume level is set too low in	Adjust the volume in the

	the options of the "WirelessMedia" Launcher program on PC.	"WirelessMedia" Launcher program on PC.
	Audio signal may be muted.	Click with right-mouse button at speaker icon in task-bar and switch on.
	The volume level is set too low.	Adjust the volume level at Options in menu of WirelessMedia.
	Audio is muted in mixer of volume in taskbar.	Right-mouse click at speaker icon in taskbar, open mixer and unmute "WirelessMedia" or "Video Playback".
	The software of used Video-player is not actual	Update Video-player. Try another player.
	An active virus scanner can block the Audio.	Check the filter-settings in Virusscanner. De-activate the player for a check.
There is no sound with MacBook.	Problem of sound-flower App, which is integrated in driver WirelessMedia.app.	<ul style="list-style-type: none"> ● You need Admin-password ● Go to the macOS System

		<p>Preferences and select the “Security & Privacy” tab.</p> <p>Find the "allow to run/install the sound-flower" there click on “Allow” next to “Matt Ingels”, in order to allow this sound-flower to install on the Mac Book.</p> <ul style="list-style-type: none"> ● Run the WirelessMedia.app again, it’ll auto-install the sound-flower to the MacBook.
There is no sound via AirPlay.	The volume is set too low, on the mobile device.	Increase the volume on the mobile device.
There is no sound at main-screen, when mirroring a video by the App “WirelessMedia for Android” .	<p>Due to the limit of the Android system, Android doesn’t provide an interface to capture the audio.</p> <p>In this case, there is no sound when mirroring the video.</p>	Use dongle or Apple Airplay to do mirroring when necessary.
Can’t update firmware of the base unit.	Flash disk format is NTFS	Please re-format the flash disk to be FAT format to update it.

<p>Can't work airplay with Macbook/Iphone/iPad.</p>	<p>Operation System Requirement</p> <p>Mac OS 10.9</p> <p>IOS 8.0 and later (WirelessMedia app)</p>	<ul style="list-style-type: none"> ● To use AirPlay, you must connect the iOS device to the Wi-Fi of WireleeMedia and enable the AirPlay feature in the Control Center. ● Update the iOS device to a newer operating system.
<p>Poor Video-quality with AirPlay.</p>	<p>There are 2 states for AirPlay:</p> <p>a.) Mirroring: 1: 1 copy of the screen</p> <p>b.) Streaming: Videos (Internet, Youtube); the image will not be displayed on the iOS device.</p> <p>=> picture is jerky</p>	<p>Reduce "Quality! In settings of Youtube, for example from "Automatic" to 720p.</p>
<p>Can't work with Android device?</p>	<p>Operation System Requirement</p> <p>Android 2.3 and later</p> <p>(WirelessMedia app)</p>	<p>Update to the later OS</p>